

MAILBOXES

COMMERCIAL & RESIDENTIAL



mailboxes.com
1-800-MAILBOX



Manufacturing Quality Products Since 1936

Salsbury Industries has excelled in manufacturing and distributing quality products for over 85 years. Our vertically integrated manufacturing and distribution facilities and our ISO 9001: 2015 Quality Management System allow us to effectively and efficiently produce components that are carefully manufactured, assembled, inspected, packaged and shipped to our valued customers. Our products are shipped from our manufacturing facilities and distribution centers in Los Angeles and Carson, California. Whether you are around the corner or around the world, most orders ship from our large inventory within 1 to 2 business days of receipt.



Salsbury Industries maintains a recycling program for the reprocessing of our aluminum, steel, and other materials.



Machinery & Capabilities

- ROBOTIC WELDING
- WATERJET CUTTING
- CNC MACHINES
- PUNCH PRESSES
- PRESS BRAKES
- TURRET PRESSES
- POWDER COATING
- STAMPING
- MILLING
- SHEARING
- SAWING
- ASSEMBLING
- PACKAGING
- SHIPPING



successful recycling program that ensures the proper reuse and steel, powder paint and corrugated materials.



Manufacturing and Distribution Facilities

Quality System

Salsbury Industries manufacturing facilities are ISO 9001: 2015 certified. ISO 9001: 2015 is an internationally recognized Quality Management System that requires a company to continually improve the effectiveness of its processes for the purposes of enhancing customer satisfaction.

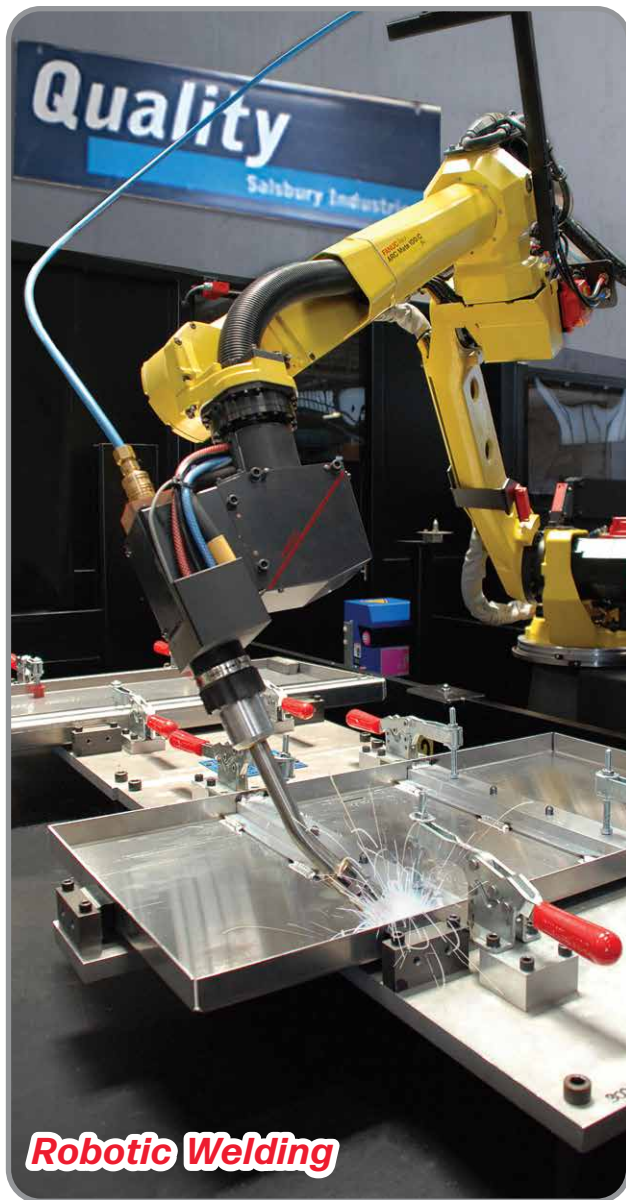

Robotic Welding



Mailbox Showroom

Centralized Mail Delivery

Centralized mail delivery is when the United States Postal Service (U.S.P.S.) delivers mail and parcels to a centralized mail location. Centralized mail delivery is typically required by the U.S.P.S. in new construction and major renovations as it is an efficient method of mail service. Highly visible centralized mail locations are safer than isolated delivery locations and provide protection against mail and parcel theft and vandalism.

Salsbury Industries Cluster Box Units (CBU's - see pages 8-15) and 4C Horizontal Mailboxes (see pages 16-31) are approved by the U.S.P.S. for centralized mail delivery. Salsbury Industries is officially licensed by the U.S.P.S. (U.S.P.S. License # 1CDSEQ-08-B-0026) to manufacture CBU's and is a U.S.P.S. approved manufacturer of 4C Horizontal Mailboxes.



Design Assistance



Architectural Resources

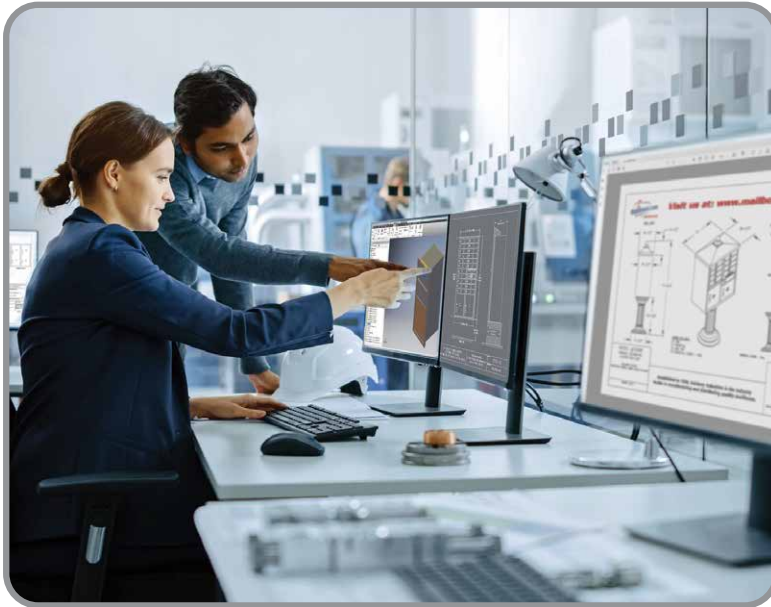

Salsbury Industries design engineers are available to architects, specification writers and individuals involved in the design of mail distribution facilities. Salsbury Industries website features an Architectural Resources section that provides product information, technical drawings, installation instructions, detailed specifications, AutoCAD Drawings and 3D Revit/BIM models for download. For more information visit: www.mailboxes.com/Architectural-Resources

On-line Resources

- Product Information
- 3D Revit / BIM Models
- Detailed Specifications
- Technical Drawings
- Installation Instructions
- AutoCAD Drawings

CBU and 4C Mailbox Configurators

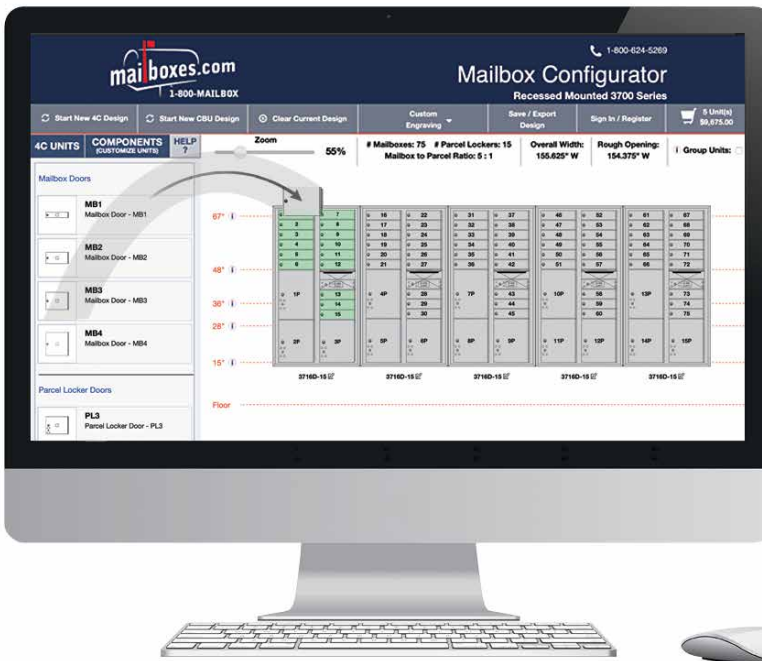

The Salsbury Industries CBU and 4C horizontal mailbox configurator is available online and will assist in determining the ideal combination of mailboxes and parcel lockers based on your specific requirements. This robust tool also allows you to customize 4C mailbox units and add numbering sequences to drawings. In addition to clear and easy to read elevation line drawings with dimensions, our online mailbox configurators will also provide you with PDF, Word, Excel and AutoCAD drawing files for your project. Access our configurators at:

www.mailboxes.com/Mailbox-Configurator

Cluster Box Units & Outdoor Parcel Lockers

continued on pages 10 - 15



Salsbury Industries is Officially Licensed by the U.S.P.S. to Manufacture Cluster Box Units (CBU's)



Salsbury 3300 series Cluster Box Units (CBU's) are manufactured to U.S.P.S. "F" specifications and are an officially licensed product of the U.S. Postal Service for centralized mail delivery.

U.S.P.S. License #: 1CDSEQ-08-B-0026

CLUSTER BOX UNITS & OUTDOOR PARCEL LOCKERS

FRONT LOADING



Made of heavy duty aluminum and stainless steel hardware, Salsbury 3300 series U.S.P.S. approved Cluster Box Units (CBU's) are accessed from the front through two (2) easy opening master door panels. The Outdoor Parcel Lockers (OPL's) are accessed from the front through one or two (2) easy opening master doors. The durable and corrosion resistant units feature a powder coated finish available in six (6) contemporary colors. Each CBU and OPL includes one or more fully integrated parcel lockers and a matching pedestal. Each pre-numbered aluminum door includes a heavy duty five (5) pin cylinder cam lock with a dust/rain shield and three (3) keys. One additional compartment in each CBU is labeled "Outgoing Mail" and includes a weather protection flap and an 11-3/4" W x 3/4" H mail slot. An attractive option for new and existing CBU and OPL installations are Salsbury 3300R series U.S.P.S. approved Regency® Decorative CBU's and OPL's - see pages 12-13.

Current Pricing and Volume Discounts Available at Mailboxes.com!

CBU MAILBOX CONFIGURATOR

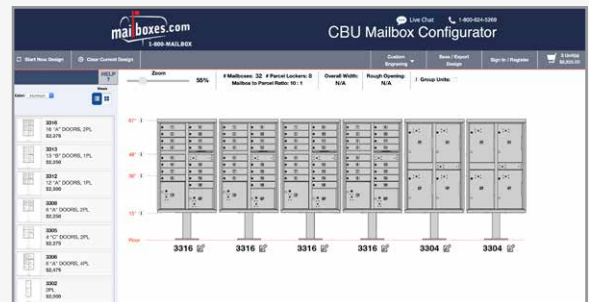

Access our CBU Configurator at:
www.mailboxes.com/Mailbox-Configurator

Our CBU mailbox configurator will assist in determining the ideal combination of mailboxes and parcel lockers based on your specific requirements. This robust tool also allows you to add numbering sequences to drawings. In addition to clear and easy to read elevation line drawings with dimensions, our online mailbox configurator will also provide you with PDF, Word, Excel and AutoCAD drawing files to download for your project. Purchasing products and requesting a quote online is simple and convenient.

#3316 in sandstone finish displayed

STANDARD FEATURES FOR CBU'S

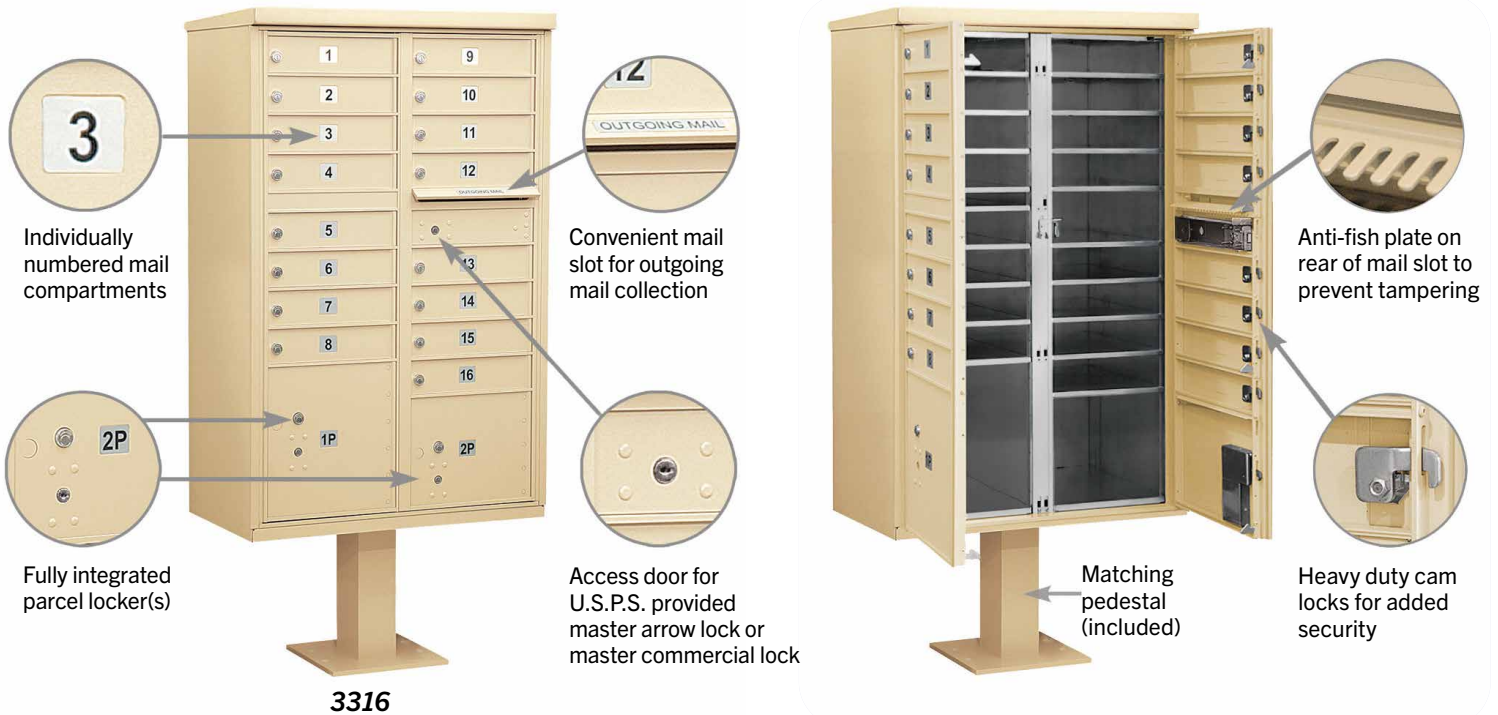

Front views of #3316 in sandstone finish displayed

STANDARD FEATURES FOR OPL'S

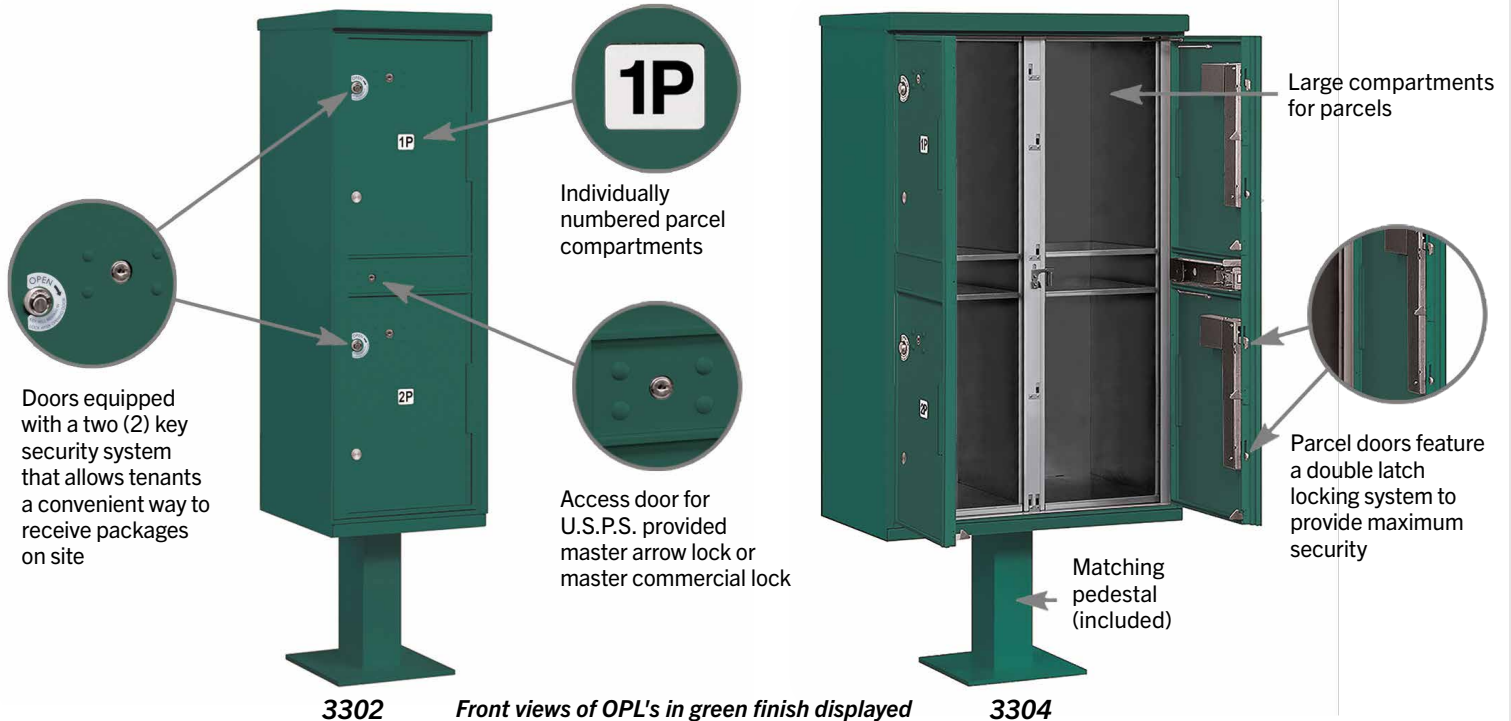

Front views of OPL's in green finish displayed

AVAILABLE COLORS

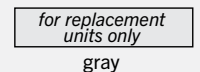
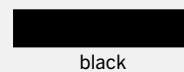
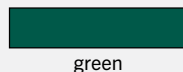
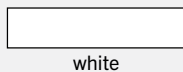
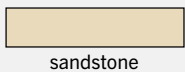

See specifications & options on page 15

Cluster Box Units & Outdoor Parcel Lockers

continued on pages 12 - 15



ALL ALUMINUM CONSTRUCTION

#3313 in bronze finish displayed

OUTDOOR PARCEL LOCKERS



includes pedestal

3302

DESCRIPTION

3302¹
Outdoor Parcel Locker
2 Compartments - Type I

(2) parcel lockers
(1) pedestal

UNIT SIZE

16" W x 62" H x 18" D

Parcel locker compartment sizes:
12" W x 19-3/4" H x 15" D

WEIGHT

100 lbs.



includes pedestal

3304

DESCRIPTION

3304¹
Outdoor Parcel Locker
4 Compartments - Type II

(4) parcel lockers
(1) pedestal

UNIT SIZE

30-1/2" W x 62" H x 18" D

Parcel locker compartment sizes:
12" W x 19-3/4" H x 15" D

WEIGHT

165 lbs.

Current Pricing and Volume Discounts Available at Mailboxes.com!

CLUSTER BOX UNITS



DESCRIPTION

3308¹
Cluster Box Unit (CBU)
8 "A" Size Doors - Type I

(8) "A" mail compartments
(2) parcel lockers
(1) pedestal

UNIT SIZE

30-1/2" W x 62" H x 18" D

Mail compartment size:
12" W x 3" H x 15" D

Parcel locker compartment sizes:
(1) 12" W x 13-1/2" H x 15" D
(1) 12" W x 10" H x 15" D

WEIGHT

155 lbs.

includes pedestal

3308

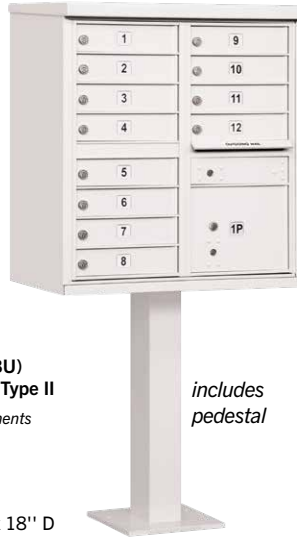

DESCRIPTION

3312¹
Cluster Box Unit (CBU)
12 "A" Size Doors - Type II

(12) "A" mail compartments
(1) parcel locker
(1) pedestal

UNIT SIZE

30-1/2" W x 62" H x 18" D

Mail compartment size:
12" W x 3" H x 15" D

Parcel locker compartment size:
12" W x 10" H x 15" D

WEIGHT

155 lbs.

includes pedestal

3312



DESCRIPTION

3305¹
Cluster Box Unit (CBU)
4 "C" Size Doors - Type V

(4) "C" mail compartments
(2) parcel lockers
(1) pedestal

UNIT SIZE

30-1/2" W x 62" H x 18" D

Mail compartment size:
12" W x 6-1/2" H x 15" D

Parcel locker compartment sizes:
(1) 12" W x 13-1/2" H x 15" D
(1) 12" W x 10" H x 15" D

WEIGHT

145 lbs.

includes pedestal

3305



DESCRIPTION

3316¹
Cluster Box Unit (CBU)
16 "A" Size Doors - Type III

(16) "A" mail compartments
(2) parcel lockers
(1) pedestal

UNIT SIZE

30-1/2" W x 62" H x 18" D

Mail compartment size:
12" W x 3" H x 15" D

Parcel locker compartment sizes:
(1) 12" W x 13-1/2" H x 15" D
(1) 12" W x 10" H x 15" D

WEIGHT

175 lbs.

includes pedestal

3316



DESCRIPTION

3313¹
Cluster Box Unit (CBU)
13 "B" Size Doors - Type IV

(13) "B" mail compartments
(1) parcel locker
(1) pedestal

UNIT SIZE

30-1/2" W x 62" H x 18" D

Mail compartment size:
12" W x 4-3/4" H x 15" D

Parcel locker compartment size:
12" W x 10" H x 15" D

WEIGHT

165 lbs.

includes pedestal

3313



DESCRIPTION

3306¹
Cluster Box Unit (CBU)
8 "A" Size Doors - Type VI

(8) "A" mail compartments
(4) parcel lockers
(1) pedestal

UNIT SIZE

30-1/2" W x 62" H x 18" D

Mail compartment size:
12" W x 3" H x 15" D

Parcel locker compartment sizes:
(3) 12" W x 13-1/2" H x 15" D
(1) 12" W x 10" H x 15" D

WEIGHT

165 lbs.

includes pedestal

3306

¹ Specify



sandstone



bronze



white



green



black

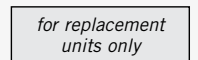

for replacement units only

gray

See specifications & options on page 15

Regency® Decorative CBU's & OPL's

continued on pages 14 - 15

Includes:

- CBU or OPL and Matching Pedestal
- Regency® Decorative Top
- Regency® Pedestal Cover



#3312R in black finish displayed

Salsbury Industries is Officially Licensed by the U.S.P.S. to Manufacture Cluster Box Units (CBU's)



Salsbury 3300 series Cluster Box Units (CBU's) are manufactured to U.S.P.S. "F" specifications and are an officially licensed product of the U.S. Postal Service for centralized mail delivery.

U.S.P.S. License #: 1CDSEQ-08-B-0026

REGENCY® DECORATIVE CBU's & OPL's FRONT LOADING USPS access

Made of heavy duty aluminum and stainless steel hardware, Salsbury 3300R series U.S.P.S. approved Regency® Decorative Cluster Box Units (CBU's) and Regency® Decorative Outdoor Parcel Lockers (OPL's) are available in an easy to order complete package that includes a Salsbury 3300 series CBU or OPL and matching pedestal, an attractive decorative top and an elegant decorative pedestal cover. USPS approved decorative tops and pedestal covers are made of die-cast aluminum and can be ordered separately - see page 14.

Current Pricing and Volume Discounts Available at Mailboxes.com!

REGENCY® OUTDOOR PARCEL LOCKER (4 DOOR UNIT ONLY)



DESCRIPTION

3304R¹
Regency® Decorative OPL
4 Compartments - Type II
(4) parcel lockers

UNIT SIZE

31" W x 71-3/4" H x 18-1/2" D

Parcel locker compartment size:
12" W x 19-3/4" H x 15" D

WEIGHT

205 lbs.

3304R



CBU CONFIGURATOR

Our CBU configurator will assist in determining the ideal combination of mailboxes and parcel lockers for your project. In addition to drawings with dimensions, our online mailbox configurator will also provide you with downloadable PDF, Word, Excel and AutoCAD drawing files.

**REGENCY®
CLUSTER BOX
UNITS**



3308R

DESCRIPTION

3308R¹
Regency® Decorative CBU
8 "A" Size Doors - Type I

(8) "A" mail compartments
(2) parcel lockers

UNIT SIZE

31" W x 71-3/4" H x 18-1/2" D

Mail compartment size:
12" W x 3" H x 15" D

Parcel locker compartment sizes:
(1) 12" W x 13-1/2" H x 15" D
(1) 12" W x 10" H x 15" D

WEIGHT

200 lbs.



3312R

DESCRIPTION

3312R¹
Regency® Decorative CBU
12 "A" Size Doors - Type II

(12) "A" mail compartments
(1) parcel locker

UNIT SIZE

31" W x 71-3/4" H x 18-1/2" D

Mail compartment size:
12" W x 3" H x 15" D

Parcel locker compartment size:
12" W x 10" H x 15" D

WEIGHT

200 lbs.



3305R

DESCRIPTION

3305R¹
Regency® Decorative CBU
4 "C" Size Doors - Type V

(4) "C" mail compartments
(2) parcel lockers

UNIT SIZE

31" W x 71-3/4" H x 18-1/2" D

Mail compartment size:
12" W x 6-1/2" H x 15" D

Parcel locker compartment sizes:
(1) 12" W x 13-1/2" H x 15" D
(1) 12" W x 10" H x 15" D

WEIGHT

190 lbs.



3316R

DESCRIPTION

3316R¹
Regency® Decorative CBU
16 "A" Size Doors - Type III

(16) "A" mail compartments
(2) parcel lockers

UNIT SIZE

31" W x 71-3/4" H x 18-1/2" D

Mail compartment size:
12" W x 3" H x 15" D

Parcel locker compartment sizes:
(1) 12" W x 13-1/2" H x 15" D
(1) 12" W x 10" H x 15" D

WEIGHT

215 lbs.



3313R

DESCRIPTION

3313R¹
Regency® Decorative CBU
13 "B" Size Doors - Type IV

(13) "B" mail compartments
(1) parcel locker

UNIT SIZE

31" W x 71-3/4" H x 18-1/2" D

Mail compartment size:
12" W x 4-3/4" H x 15" D

Parcel locker compartment size:
12" W x 10" H x 15" D

WEIGHT

205 lbs.



3306R

DESCRIPTION

3306R¹
Regency® Decorative CBU
8 "A" Size Doors - Type VI

(8) "A" mail compartments
(4) parcel lockers

UNIT SIZE

31" W x 71-3/4" H x 18-1/2" D

Mail compartment size:
12" W x 3" H x 15" D

Parcel locker compartment sizes:
(3) 12" W x 13-1/2" H x 15" D
(1) 12" W x 10" H x 15" D

WEIGHT

205 lbs.

¹ Specify



sandstone



bronze



white



green



black

See specifications & options on page 15

CBU & OPL Specifications & Options

for CBU's, OPL's and Regency® CBU's/OPL's on pages 8 - 13

REGENCY® DECORATIVE CBU & OPL ACCESSORIES - U.S.P.S. APPROVED

Made of die cast aluminum, Salsbury U.S.P.S. approved Regency® Decorative CBU and OPL accessories can be ordered separately from Salsbury 3300 series CBU's and OPL's. Decorative accessories feature a durable powder coated finish available in five (5) contemporary colors and provide an elegant finished look to CBU and OPL installations. Decorative tops (#3350) include a 3" diameter ball finial and an attractive sloping design and easily mount to the top of CBU's and OPL's with four (4) set screws (provided). Decorative pedestal covers (short - #3386 and tall - #3396) easily attach over CBU and OPL pedestals and include a plastic insect guard and installation hardware.



#3316R and #3306R in sandstone finish with optional custom engraved doors - black filled (#3374) displayed

DESCRIPTION

3350¹ - Regency® Decorative Top

- Option for #3308, #3312, #3316, #3313, #3305, #3306 and #3304
- 31" W x 11-1/2" H x 18-1/2" D



3350

WEIGHT

20 lbs.

DESCRIPTION

3386¹ - Regency® Pedestal Cover - Short

- Option for pedestal for #3316, #3313, #3306 and #3304
- 13-3/4" H x 17-3/4" diameter



3386

WEIGHT

20 lbs.

DESCRIPTION

3396¹ - Regency® Pedestal Cover - Tall

- Option for pedestal for #3308, #3312 and #3305
- 27-3/4" H x 17-3/4" diameter



3396

WEIGHT

25 lbs.

¹ Specify

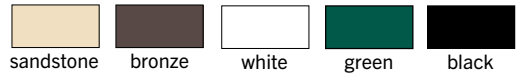

SAMPLE INSTALLATION OF REGENCY® DECORATIVE CBU/OPL ACCESSORIES



- Models displayed:
 (1) 3350 Decorative Top
 (1) 3312 CBU
 (includes pedestal)
 (1) 3396 Pedestal Cover - Tall

Decorative Top
 (#3350)

CBU (#3312)
 (includes pedestal)

Decorative Pedestal Cover - Tall (#3396)

Note: Regency® decorative tops and pedestal covers are available in a complete package that includes the CBU/OPL and pedestal (see pages 12-13).



#3316's and #3304 in bronze finish with optional custom engraved placards (#3367) displayed

CBU MAILBOX CONFIGURATOR

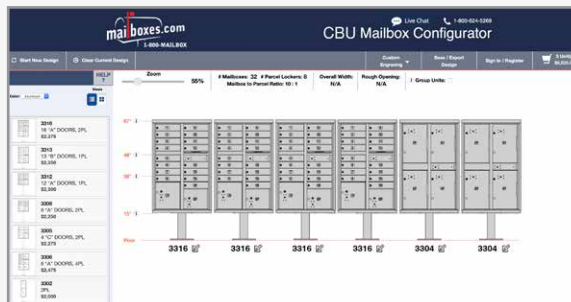

Access our CBU Configurator at:
www.mailboxes.com/Mailbox-Configurator

Our CBU mailbox configurator will assist in determining the ideal combination of mailboxes and parcel lockers based on your specific requirements. This robust tool also allows you to add numbering sequences to drawings. In addition to clear and easy to read elevation line drawings with dimensions, our online mailbox configurator will also provide you with PDF, Word, Excel and AutoCAD drawing files to download for your project. Purchasing products and requesting a quote online is simple and convenient.

CLUSTER BOX UNITS & OUTDOOR PARCEL LOCKERS SPECIFICATIONS & OPTIONS

MAILBOX DOOR SIZES

Each aluminum mailbox door includes a heavy duty five (5) pin cylinder cam lock with a dust/rain shield and three (3) keys.

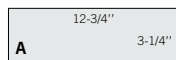

#3351¹ Replacement "A" door and lock

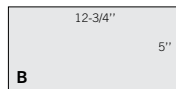

#3352¹ Replacement "B" door and lock

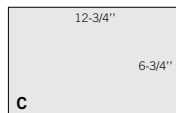

#3356¹ Replacement "C" door and lock

OUTGOING MAIL SLOT PLUG KIT

An outgoing mail slot plug kit is available for installations not serviced by the U.S.P.S. (#3370)



#3370

PARCEL LOCKER DOOR SIZES

Each CBU/OPL includes one or more fully integrated parcel lockers. Parcel lockers offer tenants a convenient way to receive packages on site and are equipped with a two (2) key security system.

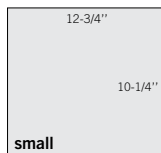

small

#3353¹ Replacement parcel locker door and tenant lock - small

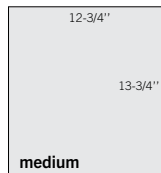

medium

#3354¹ Replacement parcel locker door and tenant lock - medium

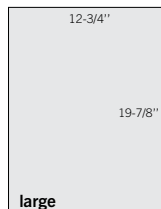

large

#3355¹ Replacement parcel locker door and tenant lock - large

FINISHES

Durable and corrosion resistant CBU's/OPL's feature a powder coated finish available in sandstone, bronze, white, green or black. Note - gray is available for replacement units only and is not available on Regency Decorative CBU's/OPL's and accessories.

1 Specify

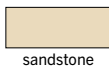

sandstone



bronze

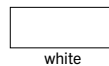

white



green



black

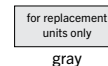

gray

IDENTIFICATION SYSTEMS

Each CBU/OPL door has a 1" high self adhesive number. The outgoing mail compartment is labeled "Outgoing Mail" and the parcel locker(s) are labeled with a "1P", "2P", etc. Custom identification systems are available as an option upon request.

CUSTOM ENGRAVED DOOR PLACARDS

1-3/4" W x 1-1/2" H custom engraved self-adhesive door placards are available as an option upon request. (#3367)



#3367

CUSTOM ENGRAVED UNIT PLACARDS

8" W x 1" H custom engraved self-adhesive unit placards are available as an option upon request. (#3363)



#3363

CUSTOM ENGRAVED DOORS

- Custom engraved door – regular (#3368)
- Custom engraved door – black filled (#3374)

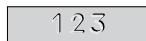

#3368

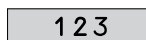

#3374

LOCKS

Each CBU/OPL door includes a heavy duty five (5) pin cylinder cam lock with a dust/rain shield and three (3) keys (2,000 different key changes).

- (#3390-5 - set of (5) #3390 locks)
- Additional keys per lock when ordering (#3398)
- Key blanks - box of (50) (#3399)

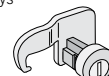

#3390

MASTER COMMERCIAL LOCK

Factory installed if for private access - for access door and parcel locker(s) - with (2) keys (#3375)

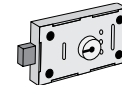

#3375

TENANT PARCEL LOCKER LOCK

For parcel locker door - with (3) keys (#3376)

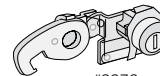

#3376

OUTDOOR PARCEL LOCK CYLINDER

For outdoor parcel locker door - with (3) keys (#3377)



#3377

Note: For E series replacement CBU locks, see 3390E on page 56.

PEDESTALS

- #3385¹ Replacement pedestal for #3316, #3313, #3306, #3302 and #3304 (14-1/2" H)
- #3395¹ Replacement pedestal for #3308, #3312 and #3305 (28-1/2" H)
- #3285 Replacement pedestal for the Neighborhood Delivery and Collection Box Unit (NDCBU)
- #3393 Pedestal mounting kit - (4) 5-1/2" H expansion wedge anchor bolts - for existing concrete
- #3394 Pedestal mounting kit - (4) 1/2" W x 8" H anchor (J) bolts - for new concrete

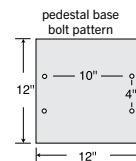
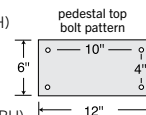

OUTGOING MAIL COMPARTMENT

Cluster Box Units (CBU's) include a compartment for outgoing mail collection that is labeled "Outgoing Mail".

Recessed Mounted 4C Horizontal Mailboxes

continued on pages 18 - 19

RECESSED MOUNTED 4C HORIZONTAL MAILBOXES

FRONT LOADING USPS or PRIVATE ACCESS

Made of heavy duty aluminum and stainless steel hardware, Salsbury 3700 series recessed mounted 4C horizontal mailboxes and parcel lockers are U.S.P.S. approved and are available with standard MB1 mailbox doors (12-3/4" W x 3-1/4" H). Larger MB2, MB3 and MB4 mailbox doors are available for custom units – see door sizes on page 31. All pre-numbered mailbox doors include a heavy duty cam lock with a dust/rain shield and three (3) keys. Recessed mounted 4C horizontal mailbox units include factory installed 1" W x 1/4" D trim and are available in configurations that are one door wide (single column) and two (2) doors wide (double column). The Salsbury maximum height units (3716D-15) have three (3) fully integrated parcel lockers (2 PL4.5 and 1PL5) and fifteen (15) standard MB1 mailbox doors and meet the U.S.P.S. 4C requirement of one parcel locker for every five (5) tenant compartments. Fully integrated and stand-alone parcel lockers are available in heights ranging from the equivalent of three (3) standard MB1 mailbox doors (PL3 - 10-1/4" high) to six (6) standard MB1 mailbox doors (PL6 - 20-3/4" high). Each unit includes a compartment for outgoing mail collection and is labeled "Outgoing Mail". The outgoing mail compartment includes a weather protection flap and a 11-3/4" W x 3/4" H mail slot. Designed for indoor or outdoor use, recessed mounted 4C horizontal mailboxes feature a durable powder coated finish available in four (4) contemporary colors.

4C

Note: Salsbury 3700 series recessed mounted 4C horizontal mailboxes and parcel lockers are U.S.P.S. approved and meet the specifications of USPS-STD-4C. These units are required for new construction and major renovations.

STANDARD FEATURES

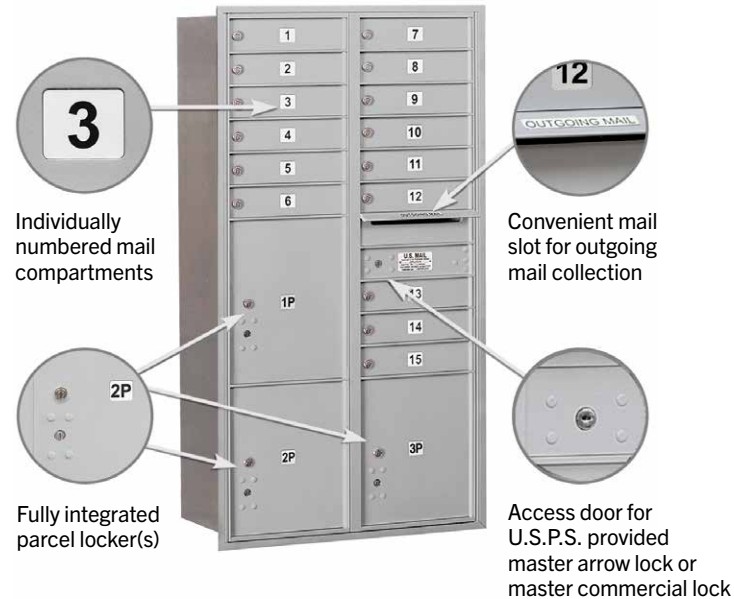

Front view of 3716D-15 Front Loading Recessed Mounted Double Column Unit displayed



ALL ALUMINUM
CONSTRUCTION

#3716D-15 maximum height recessed mounted 4C horizontal mailboxes in black finish with optional custom engraved placards (#3767) displayed

MAXIMUM HEIGHT UNITS - 57-1/8" H

11 DOOR HIGH UNITS - 41-3/8" H



3716D-20
Double Column - Front Loading



3716D-15
Double Column - Front Loading



3711D-20
Double Column - Front Loading



3711D-10
Double Column - Front Loading

RECESSED MOUNTED 4C HORIZONTAL MAILBOXES - FRONT LOADING - U.S.P.S. APPROVED

MODEL	DESCRIPTION	UNIT SIZE (includes trim)	WEIGHT
MAXIMUM HEIGHT UNITS - 57-1/8" H (maximum allowable height)			
3716D-20 ^{1,2}	20 MB1 Doors and 2 Parcel Lockers (PL4.5's)	31-1/8" W x 57-1/8" H x 16-1/2" D	170 lbs.
3716D-15 ^{1,2}	15 MB1 Doors and 3 Parcel Lockers (PL4.5's, PL5)	31-1/8" W x 57-1/8" H x 16-1/2" D	160 lbs.
3716D-10 ^{1,2}	10 MB1 Doors and 4 Parcel Lockers (PL4.5's, PL5's)	31-1/8" W x 57-1/8" H x 16-1/2" D	150 lbs.
3716D-6P ^{1,2}	6 Parcel Lockers (PL4.5's, PL5's, PL6's)	31-1/8" W x 57-1/8" H x 16-1/2" D	145 lbs.
3716S-09 ^{1,2}	9 MB1 Doors and 1 Parcel Locker (PL4.5)	17" W x 57-1/8" H x 16-1/2" D	85 lbs.
3716S-06 ^{1,2}	6 MB1 Doors and 2 Parcel Lockers (PL3, PL4.5)	17" W x 57-1/8" H x 16-1/2" D	85 lbs.
3716S-3P ^{1,2}	3 Parcel Lockers (PL4.5, PL5, PL6)	17" W x 57-1/8" H x 16-1/2" D	80 lbs.

MAXIMUM HEIGHT UNITS - 57-1/8" H

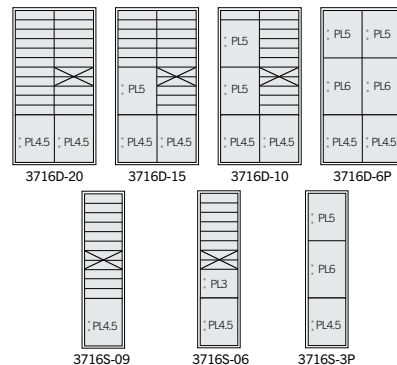

MODEL	DESCRIPTION	UNIT SIZE (includes trim)	WEIGHT
11 DOOR HIGH UNITS - 41-3/8" H (equivalent to 11 standard mailbox doors (MB1) high)			
3711D-20 ^{1,2}	20 MB1 Doors - no Parcel Lockers	31-1/8" W x 41-3/8" H x 16-1/2" D	145 lbs.
3711D-15 ^{1,2}	15 MB1 Doors and 1 Parcel Locker (PL5)	31-1/8" W x 41-3/8" H x 16-1/2" D	135 lbs.
3711D-10 ^{1,2}	10 MB1 Doors and 2 Parcel Lockers (PL5's)	31-1/8" W x 41-3/8" H x 16-1/2" D	135 lbs.
3711D-4P ^{1,2}	4 Parcel Lockers (PL5's, PL6's)	31-1/8" W x 41-3/8" H x 16-1/2" D	130 lbs.
3711S-09 ^{1,2}	9 MB1 Doors - no Parcel Lockers	17" W x 41-3/8" H x 16-1/2" D	75 lbs.
3711S-04 ^{1,2}	4 MB1 Doors and 1 Parcel Locker (PL5)	17" W x 41-3/8" H x 16-1/2" D	75 lbs.
3711S-2P ^{1,2}	2 Parcel Lockers (PL5, PL6)	17" W x 41-3/8" H x 16-1/2" D	65 lbs.

11 DOOR HIGH UNITS - 41-3/8" H

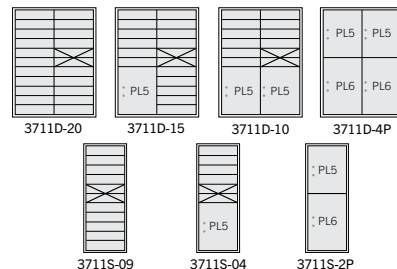

Current Pricing and Volume Discounts Available at Mailboxes.com!

¹ Specify



aluminum



bronze



sandstone



black

² Specify - U.S.P.S. access or private access (order #3775 master commercial lock for private access on FL units and PL's)

more
recessed mounted
4C horizontal mailboxes
available on pages 18-19 and on-line

Recessed Mounted 4C Horizontal Mailboxes

for custom 4C mailbox units and options — see pages 28-31

ARCHITECTURAL RESOURCES ONLINE

visit: www.mailboxes.com/Architectural-Resources

- Product Information
- 3D Revit / BIM Models
- Detailed Specifications
- Technical Drawings
- Installation Instructions
- AutoCAD Drawings
- Color Chart
- ADA Compliant Units Available 

- see page 19 or visit: www.mailboxes.com/ADA-4C-Mailboxes



4C

Note: Salisbury 3700 series recessed mounted 4C horizontal mailboxes and parcel lockers are U.S.P.S. approved and meet the specifications of USPS-STD-4C. These units are required for new construction and major renovations.

4C MAILBOX CONFIGURATOR

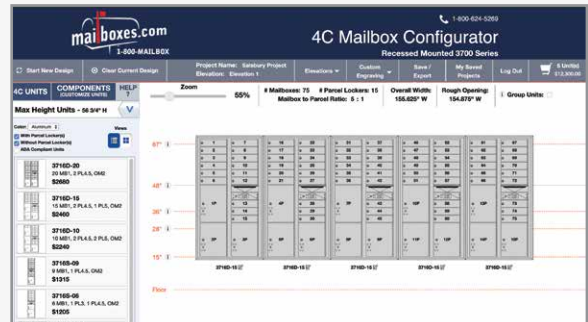

Access our 4C Configurator at:
www.mailboxes.com/Mailbox-Configurator

Our 4C mailbox configurator will assist in determining the ideal combination of mailboxes and parcel lockers based on your specific requirements. This robust tool also allows you to customize 4C mailbox units and add numbering sequences to drawings. In addition to clear and easy to read elevation line drawings with dimensions, our online mailbox configurator will also provide you with PDF, Word, Excel and AutoCAD drawing files to download for your project. Purchasing products and requesting a quote online is simple and convenient.

4C CONNECTOR KIT

Made of heavy duty aluminum, 4C horizontal mailbox connector kits easily connect multiple recessed mounted mailbox units providing easy installation. Each standard and custom recessed mounted 4C horizontal mailbox unit includes one mailbox connector kit (hardware included).

- Models displayed:
- (2) 3716D-15 Front Loading Units
 - (1) 3716CK Connector Kit

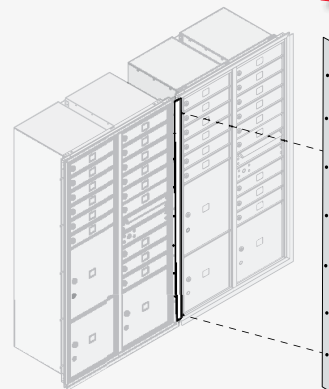

4C horizontal mailbox connector kits connect recessed mounted units side by side and eliminate the need for wood studs between the units.

Note: For installations accessed by the U.S. Postal Service, the tenant locks in the top row of mailboxes must be no more than 67" above the finished floor and the bottom shelf of the lowest row of mailboxes must be no less than 28" above the finished floor. The U.S.P.S. master arrow lock must be a minimum of 36" and a maximum of 48" above the finished floor. The bottom shelf of parcel lockers must be at least 15" above the finished floor.



#3710D-10 recessed mounted 4C horizontal mailboxes in bronze finish with optional custom engraved placards (#3767) displayed

10 DOOR HIGH UNITS* - 37-7/8" H

6 DOOR HIGH UNITS* - 23-7/8" H



3710D-10

Double Column - Front Loading



3710S-04

Single Column - Front Loading



3706D-10

Double Column - Front Loading



3706S-04

Single Column - Front Loading



* All units meet ADA reach requirements when installed with the tenant locks in the top row of mailboxes no more than 48" above the finished floor and the bottom shelf of the lowest row of mailboxes no less than 28" above the finished floor.

RECESSED MOUNTED 4C HORIZONTAL MAILBOXES - FRONT LOADING - U.S.P.S. APPROVED

MODEL	DESCRIPTION	UNIT SIZE (includes trim)	WEIGHT
10 DOOR HIGH UNITS - 37-7/8" H (equivalent to 10 standard mailbox doors (MB1) high)			
3710D-10 ^{1,2}	10 MB1 Doors and 2 Parcel Lockers (PL4, PL4.5)	31-1/8" W x 37-7/8" H x 16-1/2" D	130 lbs.
3710D-09 ^{1,2}	9 MB1 Doors and 2 Parcel Lockers (PL4.5, PL5)	31-1/8" W x 37-7/8" H x 16-1/2" D	130 lbs.
3710D-06 ^{1,2}	6 MB1 Doors and 2 Parcel Lockers (PL6's)	31-1/8" W x 37-7/8" H x 16-1/2" D	125 lbs.
3710D-4P ^{1,2}	4 Parcel Lockers (PL5's)	31-1/8" W x 37-7/8" H x 16-1/2" D	120 lbs.
3710S-04 ^{1,2}	4 MB1 Doors and 1 Parcel Locker (PL4.5)	17" W x 37-7/8" H x 16-1/2" D	75 lbs.
3710S-03 ^{1,2}	3 MB1 Doors and 1 Parcel Locker (PL5)	17" W x 37-7/8" H x 16-1/2" D	70 lbs.
3710S-2P ^{1,2}	2 Parcel Lockers (PL5's)	17" W x 37-7/8" H x 16-1/2" D	65 lbs.

10 DOOR HIGH UNITS - 37-7/8" H

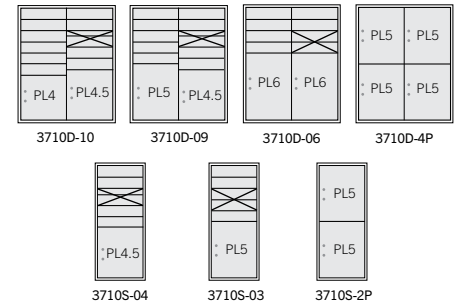

MODEL	DESCRIPTION	UNIT SIZE (includes trim)	WEIGHT
6 DOOR HIGH UNITS - 23-7/8" H (equivalent to 6 standard mailbox doors (MB1) high)			
3706D-10 ^{1,2}	10 MB1 Doors - no Parcel Lockers	31-1/8" W x 23-7/8" H x 16-1/2" D	90 lbs.
3706D-09 ^{1,2}	9 MB1 Doors - no Parcel Lockers	31-1/8" W x 23-7/8" H x 16-1/2" D	90 lbs.
3706D-05 ^{1,2}	5 MB1 Doors and 1 Parcel Locker (PL5)	31-1/8" W x 23-7/8" H x 16-1/2" D	85 lbs.
3706D-2P ^{1,2}	2 Parcel Lockers (PL6's)	31-1/8" W x 23-7/8" H x 16-1/2" D	80 lbs.
3706S-04 ^{1,2}	4 MB1 Doors - no Parcel Lockers	17" W x 23-7/8" H x 16-1/2" D	50 lbs.
3706S-03 ^{1,2}	3 MB1 Doors - no Parcel Lockers	17" W x 23-7/8" H x 16-1/2" D	50 lbs.
3706S-1P ^{1,2}	1 Parcel Locker (PL6)	17" W x 23-7/8" H x 16-1/2" D	45 lbs.

6 DOOR HIGH UNITS - 23-7/8" H



Current Pricing and Volume Discounts Available at Mailboxes.com!

¹ Specify

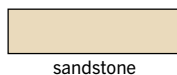

² Specify - U.S.P.S. access or private access (order #3775 master commercial lock for private access on FL units and PL's)

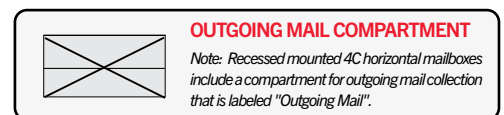

For custom 4C mailbox units, specifications & options - see pages 28-31

Surface Mounted 4C Horizontal Mailboxes

continued on pages 22 - 23

SURFACE MOUNTED 4C HORIZONTAL MAILBOXES FRONT LOADING



Made of heavy duty aluminum and stainless steel hardware, Salsbury 3800 series surface mounted 4C horizontal mailboxes are accessed from the front through one or two (2) easy opening master door panels. Surface mounted 4C horizontal mailboxes include a U.S.P.S. approved 4C horizontal mailbox and matching surface mounted enclosure and are available in configurations that are one door wide (single column) and two (2) doors wide (double column). The durable and corrosion resistant units feature a powder coated finish available in four (4) contemporary colors and are designed for indoor and outdoor use. Surface mounted 4C horizontal mailboxes are available with standard mailbox doors (MB1) that are 12-3/4" W x 3-1/4" H. Larger MB2, MB3 and MB4 mailbox doors are available for custom units - see door sizes on page 31. All pre-numbered mailbox doors include a heavy duty cam lock with a dust/rain shield and three (3) keys. Each unit includes a compartment for outgoing mail collection and is labeled "Outgoing Mail". The outgoing mail compartment includes a weather protection flap and an 11-3/4" W x 3/4" H mail slot. Fully integrated and stand-alone parcel lockers are available in heights ranging from the equivalent of three (3) standard MB1 mailbox doors (PL3 - 10-1/4" high) to six (6) standard MB1 mailbox doors (PL6 - 20-3/4" high). The Salsbury maximum height units (3816D-15) have three (3) fully integrated parcel lockers (2 PL4.5 and 1PL5) and fifteen (15) standard MB1 mailbox doors and meet the U.S.P.S. 4C requirement of one parcel locker for every five (5) tenant compartments. Surface mounted 4C horizontal mailboxes provide a convenient means of installing 4C horizontal mailboxes in locations where walls cannot accommodate a recessed mounted installation.



#3816D-15 maximum height surface mounted 4C horizontal mailbox unit in aluminum finish displayed

4C

Note: Salsbury 3800 series surface mounted 4C horizontal mailboxes include a U.S.P.S. approved 4C horizontal mailbox unit and a matching enclosure. 4C mailboxes are required for new construction and major renovations.

4C MAILBOX CONFIGURATOR

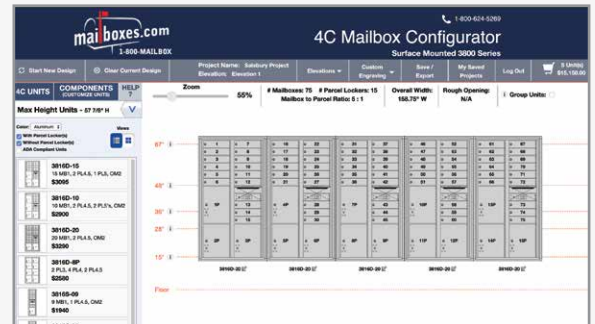

Access our 4C Configurator at:

www.mailboxes.com/Mailbox-Configurator

Our 4C mailbox configurator will assist in determining the ideal combination of mailboxes and parcel lockers based on your specific requirements. This robust tool also allows you to customize 4C mailbox units and add numbering sequences to drawings. In addition to clear and easy to read elevation line drawings with dimensions, our online mailbox configurator will also provide you with PDF, Word, Excel and AutoCAD drawing files to download for your project. Purchasing products and requesting a quote online is simple and convenient.

SAMPLE SURFACE MOUNT INSTALLATION

Model displayed: 3816D-15

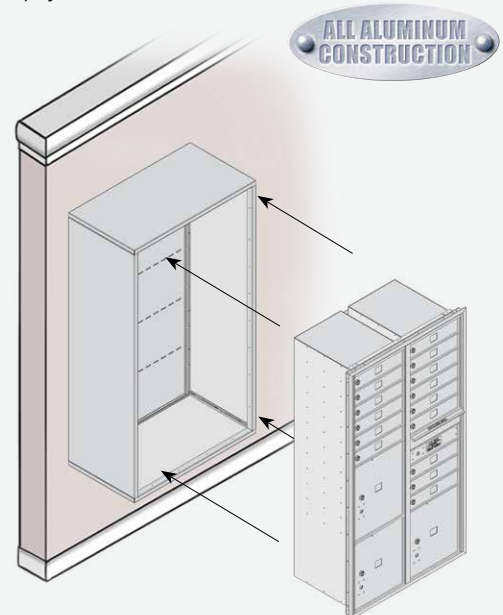

Note: For installations accessed by the U.S. Postal Service, the tenant locks in the top row of mailboxes must be no more than 67" above the finished floor and the bottom shelf of the lowest row of mailboxes must be no less than 28" above the finished floor. The U.S.P.S. master arrow lock must be a minimum of 36" and a maximum of 48" above the finished floor. The bottom shelf of parcel lockers must be at least 15" above the finished floor.

MAXIMUM HEIGHT UNITS - 57-3/4" H

11 DOOR HIGH UNITS - 42" H



3816D-20



3816D-15



3811D-20



3811D-10

SURFACE MOUNTED 4C HORIZONTAL MAILBOXES - INCLUDES 4C MAILBOX AND ENCLOSURE

MODEL	DESCRIPTION	UNIT SIZE (includes enclosure)	WEIGHT
MAXIMUM HEIGHT UNITS - 57-3/4" H (includes enclosure)			
3816D-20 ^{1,2}	20 MB1 Doors and 2 Parcel Lockers (PL4.5's)	31-3/4" W x 57-3/4" H x 17" D	225 lbs.
3816D-15 ^{1,2}	15 MB1 Doors and 3 Parcel Lockers (PL4.5's, PL5)	31-3/4" W x 57-3/4" H x 17" D	215 lbs.
3816D-10 ^{1,2}	10 MB1 Doors and 4 Parcel Lockers (PL4.5's, PL5's)	31-3/4" W x 57-3/4" H x 17" D	205 lbs.
3816D-6P ^{1,2}	6 Parcel Lockers (PL4.5's, PL5's, PL6's)	31-3/4" W x 57-3/4" H x 17" D	200 lbs.
3816S-09 ^{1,2}	9 MB1 Doors and 1 Parcel Locker (PL4.5)	17-3/4" W x 57-3/4" H x 17" D	130 lbs.
3816S-06 ^{1,2}	6 MB1 Doors and 2 Parcel Lockers (PL3, PL4.5)	17-3/4" W x 57-3/4" H x 17" D	130 lbs.
3816S-3P ^{1,2}	3 Parcel Lockers (PL4.5, PL5, PL6)	17-3/4" W x 57-3/4" H x 17" D	125 lbs.

MAXIMUM HEIGHT UNITS - 57-3/4" H

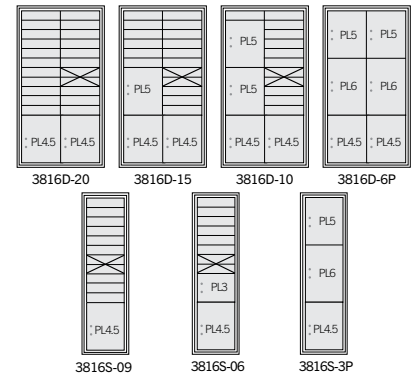

MODEL	DESCRIPTION	UNIT SIZE (includes enclosure)	WEIGHT
11 DOOR HIGH UNITS - 42" H (includes enclosure)			
3811D-20 ^{1,2}	20 MB1 Doors - no Parcel Lockers	31-3/4" W x 42" H x 17" D	185 lbs.
3811D-15 ^{1,2}	15 MB1 Doors and 1 Parcel Locker (PL5)	31-3/4" W x 42" H x 17" D	175 lbs.
3811D-10 ^{1,2}	10 MB1 Doors and 2 Parcel Lockers (PL5's)	31-3/4" W x 42" H x 17" D	175 lbs.
3811D-4P ^{1,2}	4 Parcel Lockers (PL5's, PL6's)	31-3/4" W x 42" H x 17" D	170 lbs.
3811S-09 ^{1,2}	9 MB1 Doors - no Parcel Lockers	17-3/4" W x 42" H x 17" D	105 lbs.
3811S-04 ^{1,2}	4 MB1 Doors and 1 Parcel Locker (PL5)	17-3/4" W x 42" H x 17" D	105 lbs.
3811S-2P ^{1,2}	2 Parcel Lockers (PL5, PL6)	17-3/4" W x 42" H x 17" D	95 lbs.

11 DOOR HIGH UNITS - 42" H

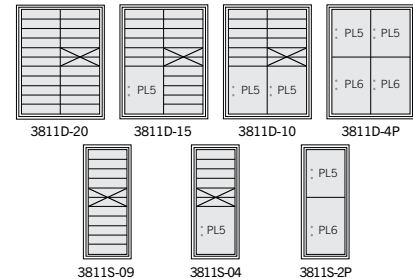

Current Pricing and Volume Discounts Available at Mailboxes.com!



² Specify - U.S.P.S. access or private access (order #3775 master commercial lock for private access on FL units and PL's)

Surface Mounted 4C Horizontal Mailboxes

for custom 4C mailbox units and options — see pages 28 - 31

IDEAL FOR INSTALLATIONS WITH LIMITED WALL DEPTH

- Easily Mounted to Any Flat Surface
- Fully Integrated Parcel Locker(s)
- For Indoor or Outdoor Use
- Engraved Doors or Placards Available
- ADA Compliant Units Available 
 - see page 23 or visit: www.mailboxes.com/ADA-4C-Mailboxes



#3810D-10 surface mounted 4C horizontal mailboxes in sandstone finish with optional custom engraved placards (#3767) displayed

4C

Note: Salsbury 3800 series surface mounted 4C horizontal mailboxes include a U.S.P.S. approved 4C horizontal mailbox unit and a matching enclosure. 4C mailboxes are required for new construction and major renovations.

STANDARD FEATURES

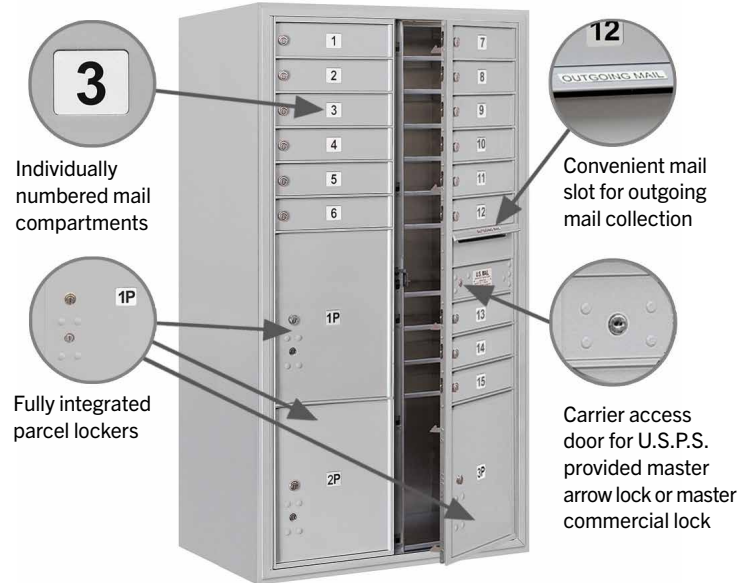

Front views of 3816D-15 in aluminum finish displayed



**ALL ALUMINUM
CONSTRUCTION**

10 DOOR HIGH UNITS* - 38-1/2" H

6 DOOR HIGH UNITS* - 24-1/2" H



3810D-10



3810S-04



3806D-10



3806S-04



* All units meet ADA reach requirements when installed with the tenant locks in the top row of mailboxes no more than 48" above the finished floor and the bottom shelf of the lowest row of mailboxes no less than 28" above the finished floor.

SURFACE MOUNTED 4C HORIZONTAL MAILBOXES - INCLUDES 4C MAILBOX AND ENCLOSURE

MODEL	DESCRIPTION	UNIT SIZE (includes enclosure)	WEIGHT
10 DOOR HIGH UNITS - 38-1/2" H (includes enclosure)			
3810D-10 ^{1,2}	10 MB1 Doors and 2 Parcel Lockers (PL4, PL4.5)	31-3/4" W x 38-1/2" H x 17" D	165 lbs.
3810D-09 ^{1,2}	9 MB1 Doors and 2 Parcel Lockers (PL4.5, PL5)	31-3/4" W x 38-1/2" H x 17" D	165 lbs.
3810D-06 ^{1,2}	6 MB1 Doors and 2 Parcel Lockers (PL6's)	31-3/4" W x 38-1/2" H x 17" D	160 lbs.
3810D-4P ^{1,2}	4 Parcel Lockers (PL5's)	31-3/4" W x 38-1/2" H x 17" D	155 lbs.
3810S-04 ^{1,2}	4 MB1 Doors and 1 Parcel Locker (PL4.5)	17-3/4" W x 38-1/2" H x 17" D	100 lbs.
3810S-03 ^{1,2}	3 MB1 Doors and 1 Parcel Locker (PL5)	17-3/4" W x 38-1/2" H x 17" D	95 lbs.
3810S-2P ^{1,2}	2 Parcel Lockers (PL5's)	17-3/4" W x 38-1/2" H x 17" D	90 lbs.

10 DOOR HIGH UNITS - 38-1/2" H

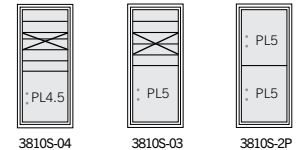
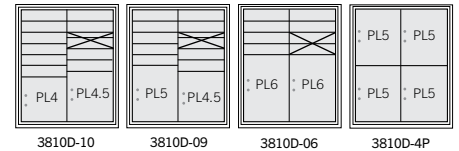

MODEL	DESCRIPTION	UNIT SIZE (includes enclosure)	WEIGHT
6 DOOR HIGH UNITS - 24-1/2" H (includes enclosure)			
3806D-10 ^{1,2}	10 MB1 Doors - no Parcel Lockers	31-3/4" W x 24-1/2" H x 17" D	115 lbs.
3806D-09 ^{1,2}	9 MB1 Doors - no Parcel Lockers	31-3/4" W x 24-1/2" H x 17" D	115 lbs.
3806D-05 ^{1,2}	5 MB1 Doors and 1 Parcel Locker (PL5)	31-3/4" W x 24-1/2" H x 17" D	110 lbs.
3806D-2P ^{1,2}	2 Parcel Lockers (PL6's)	31-3/4" W x 24-1/2" H x 17" D	105 lbs.
3806S-04 ^{1,2}	4 MB1 Doors - no Parcel Lockers	17-3/4" W x 24-1/2" H x 17" D	65 lbs.
3806S-03 ^{1,2}	3 MB1 Doors - no Parcel Lockers	17-3/4" W x 24-1/2" H x 17" D	65 lbs.
3806S-1P ^{1,2}	1 Parcel Locker (PL6)	17-3/4" W x 24-1/2" H x 17" D	60 lbs.

6 DOOR HIGH UNITS - 24-1/2" H

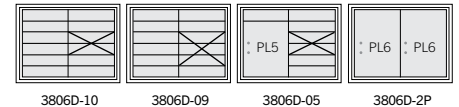

Current Pricing and Volume Discounts Available at Mailboxes.com!

¹ Specify

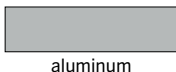

aluminum



bronze



sandstone



black

² Specify - U.S.P.S. access or private access (order #3775 master commercial lock for private access on FL units and PL's)

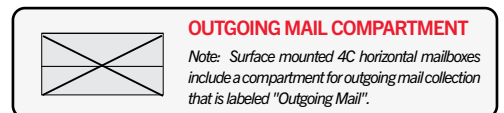

OUTGOING MAIL COMPARTMENT

Note: Surface mounted 4C horizontal mailboxes include a compartment for outgoing mail collection that is labeled "Outgoing Mail".

For custom 4C mailbox units, specifications & options - see pages 28-31

Free-Standing 4C Horizontal Mailboxes

continued on pages 26 - 27

FREE-STANDING 4C HORIZONTAL MAILBOXES FRONT LOADING



Made of heavy duty aluminum and stainless steel hardware, Salsbury 3900 series free-standing 4C horizontal mailboxes are accessed from the front through one or two (2) easy opening master door panels. Free-standing 4C horizontal mailboxes include a U.S.P.S. approved 4C horizontal mailbox and matching free-standing enclosure and are available in configurations that are one door wide (single column) and two (2) doors wide (double column). The durable and corrosion resistant units feature a powder coated finish available in four (4) contemporary colors and are designed for indoor and outdoor use. Free-standing 4C mailboxes are available with standard mailbox doors (MB1) that are 12-3/4" W x 3-1/4" H. Larger MB2, MB3 and MB4 mailbox doors are available for custom units - see door sizes on page 31. All pre-numbered mailbox doors include a heavy duty cam lock with a dust/rain shield and three (3) keys. Each unit includes a compartment for outgoing mail collection and is labeled "Outgoing Mail". The outgoing mail compartment includes a weather protection flap and an 11-3/4" W x 3/4" H mail slot. Fully integrated and stand-alone parcel lockers are available in heights ranging from the equivalent of three (3) standard MB1 mailbox doors (PL3 - 10-1/4" high) to six (6) standard MB1 mailbox doors (PL6 - 20-3/4" high). The Salsbury maximum height units (3916D-15) have three (3) fully integrated parcel lockers (2 PL4.5 and 1PL5) and fifteen (15) standard MB1 mailbox doors and meet the U.S.P.S. 4C requirement of one parcel locker for every five (5) tenant compartments. Free-standing 4C horizontal mailboxes provide a convenient means of installing 4C horizontal mailboxes in locations where a wall mounted application is not desired or available.



#3916D-15 maximum height free-standing 4C horizontal mailbox unit in aluminum finish displayed

4C

Note: Salsbury 3900 series free-standing 4C horizontal mailboxes include a U.S.P.S. approved 4C horizontal mailbox unit and a matching enclosure. 4C mailboxes are required for new construction and major renovations.

4C MAILBOX CONFIGURATOR

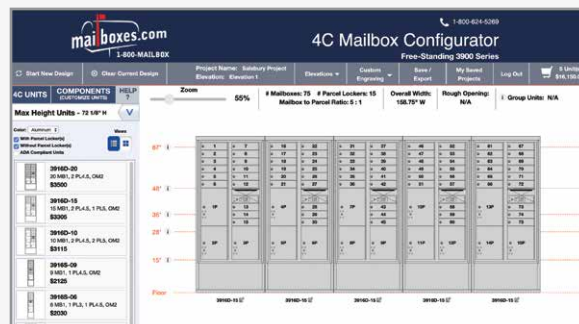

Access our 4C Configurator at:
www.mailboxes.com/Mailbox-Configurator

Our 4C mailbox configurator will assist in determining the ideal combination of mailboxes and parcel lockers based on your specific requirements. This robust tool also allows you to customize 4C mailbox units and add numbering sequences to drawings. In addition to clear and easy to read elevation line drawings with dimensions, our online mailbox configurator will also provide you with PDF, Word, Excel and AutoCAD drawing files to download for your project. Purchasing products and requesting a quote online is simple and convenient.

SAMPLE FREE-STANDING INSTALLATION

Model displayed: 3916D-15

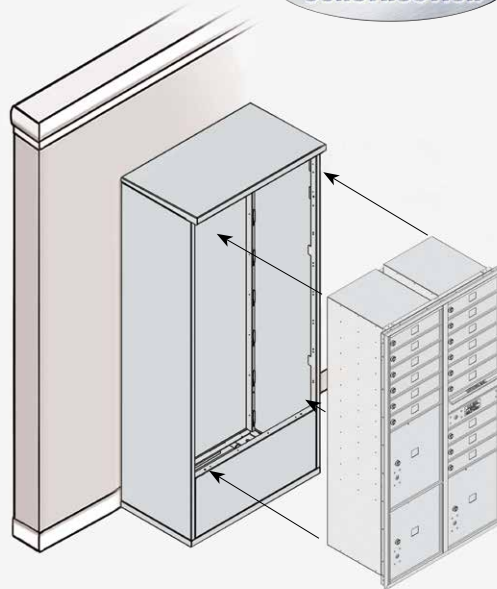

Note: It is recommended that all free-standing 4C horizontal mailbox units be floor and/or wall anchored.

MAXIMUM HEIGHT UNITS - 72-1/8" H

11 DOOR HIGH UNITS - 69-3/8" H



3916D-20



3916D-15



3911D-20



3911D-10

FREE-STANDING 4C HORIZONTAL MAILBOXES - INCLUDES 4C MAILBOX AND ENCLOSURE

MODEL	DESCRIPTION	UNIT SIZE (includes enclosure)	WEIGHT
MAXIMUM HEIGHT UNITS - 72-1/8" H (includes enclosure)			
3916D-20 ^{1,2}	20 MB1 Doors and 2 Parcel Lockers (PL4.5's)	31-3/4" W x 72-1/8" H x 18-1/2"D	255 lbs.
3916D-15 ^{1,2}	15 MB1 Doors and 3 Parcel Lockers (PL4.5's, PL5)	31-3/4" W x 72-1/8" H x 18-1/2"D	245 lbs.
3916D-10 ^{1,2}	10 MB1 Doors and 4 Parcel Lockers (PL4.5's, PL5's)	31-3/4" W x 72-1/8" H x 18-1/2"D	235 lbs.
3916D-6P ^{1,2}	6 Parcel Lockers (PL4.5's, PL5's, PL6's)	31-3/4" W x 72-1/8" H x 18-1/2"D	230 lbs.
3916S-09 ^{1,2}	9 MB1 Doors and 1 Parcel Locker (PL4.5)	17-3/4" W x 72-1/8" H x 18-1/2"D	145 lbs.
3916S-06 ^{1,2}	6 MB1 Doors and 2 Parcel Lockers (PL3, PL4.5)	17-3/4" W x 72-1/8" H x 18-1/2"D	145 lbs.
3916S-3P ^{1,2}	3 Parcel Lockers (PL4.5, PL5, PL6)	17-3/4" W x 72-1/8" H x 18-1/2"D	140 lbs.

MAXIMUM HEIGHT UNITS - 72-1/8" H

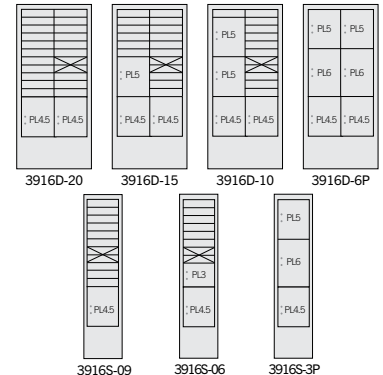

MODEL	DESCRIPTION	UNIT SIZE (includes enclosure)	WEIGHT
11 DOOR HIGH UNITS - 69-3/8" H (includes enclosure)			
3911D-20 ^{1,2}	20 MB1 Doors - no Parcel Lockers	31-3/4" W x 69-3/8" H x 18-1/2"D	225 lbs.
3911D-15 ^{1,2}	15 MB1 Doors and 1 Parcel Locker (PL5)	31-3/4" W x 69-3/8" H x 18-1/2"D	215 lbs.
3911D-10 ^{1,2}	10 MB1 Doors and 2 Parcel Lockers (PL5's)	31-3/4" W x 69-3/8" H x 18-1/2"D	215 lbs.
3911D-4P ^{1,2}	4 Parcel Lockers (PL5's, PL6's)	31-3/4" W x 69-3/8" H x 18-1/2"D	210 lbs.
3911S-09 ^{1,2}	9 MB1 Doors - no Parcel Lockers	17-3/4" W x 69-3/8" H x 18-1/2"D	130 lbs.
3911S-04 ^{1,2}	4 MB1 Doors and 1 Parcel Locker (PL5)	17-3/4" W x 69-3/8" H x 18-1/2"D	130 lbs.
3911S-2P ^{1,2}	2 Parcel Lockers (PL5, PL6)	17-3/4" W x 69-3/8" H x 18-1/2"D	120 lbs.

11 DOOR HIGH UNITS - 69-3/8" H

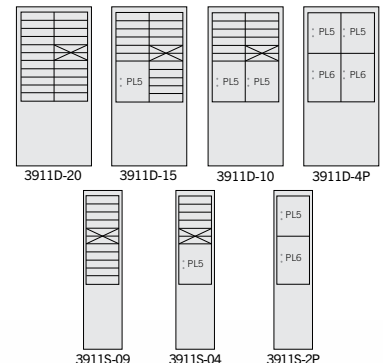

Current Pricing and Volume Discounts Available at Mailboxes.com!

¹ Specify

aluminum	bronze	sandstone	black

² Specify - U.S.P.S. access or private access (order #3775 master commercial lock for private access on FL units and PL's)

more
free-standing
4C horizontal mailboxes
available on pages 26-27 and on-line

Free-Standing 4C Horizontal Mailboxes

for custom 4C mailbox units and options – see pages 28 - 31

IDEAL WHEN WALL INSTALLATIONS ARE NOT AVAILABLE

- *Outgoing Mail Compartment*
 - *Fully Integrated Parcel Locker(s)*
 - *For Indoor or Outdoor Use*
 - *Engraved Doors or Placards Available*
 - *ADA Compliant Units Available* 
- see page 27 or visit: www.mailboxes.com/ADA-4C-Mailboxes



#3916D-15 maximum height free-standing 4C horizontal mailboxes in bronze finish with optional custom engraved doors - regular (#3768) displayed

4C

Note: Salsbury 3900 series free-standing 4C horizontal mailboxes include a U.S.P.S. approved 4C horizontal mailbox unit and a matching enclosure. 4C mailboxes are required for new construction and major renovations.

STANDARD FEATURES

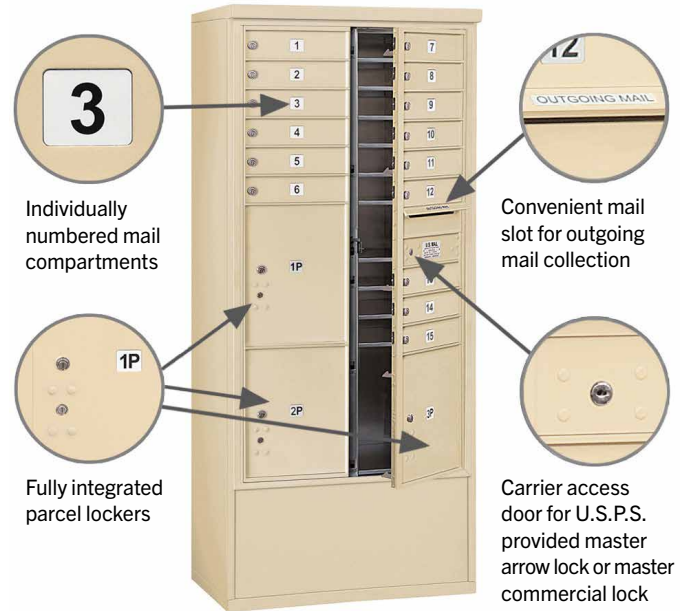

Front views of 3916D-15 in sandstone finish displayed



**ALL ALUMINUM
CONSTRUCTION**

10 DOOR HIGH UNITS* - 52-7/8" H

6 DOOR HIGH UNITS* - 52-7/8" H



3910D-10



3910S-04



3906D-10



3906S-04



* All units meet ADA reach requirements when installed with the tenant locks in the top row of mailboxes no more than 48" above the finished floor and the bottom shelf of the lowest row of mailboxes no less than 28" above the finished floor.

FREE-STANDING 4C HORIZONTAL MAILBOXES - INCLUDES 4C MAILBOX AND ENCLOSURE

MODEL	DESCRIPTION	UNIT SIZE (includes enclosure)	WEIGHT
10 DOOR HIGH UNITS - 52-7/8" H (includes ADA compliant enclosure)			
3910D-10 ^{1,2}	10 MB1 Doors and 2 Parcel Lockers (PL4, PL4.5)	31-3/4" W x 52-7/8" H x 18-1/2" D	190 lbs.
3910D-09 ^{1,2}	9 MB1 Doors and 2 Parcel Lockers (PL4.5, PL5)	31-3/4" W x 52-7/8" H x 18-1/2" D	190 lbs.
3910D-06 ^{1,2}	6 MB1 Doors and 2 Parcel Lockers (PL6's)	31-3/4" W x 52-7/8" H x 18-1/2" D	185 lbs.
3910D-4P ^{1,2}	4 Parcel Lockers (PL5's)	31-3/4" W x 52-7/8" H x 18-1/2" D	180 lbs.
3910S-04 ^{1,2}	4 MB1 Doors and 1 Parcel Locker (PL4.5)	17-3/4" W x 52-7/8" H x 18-1/2" D	110 lbs.
3910S-03 ^{1,2}	3 MB1 Doors and 1 Parcel Locker (PL5)	17-3/4" W x 52-7/8" H x 18-1/2" D	105 lbs.
3910S-2P ^{1,2}	2 Parcel Lockers (PL5's)	17-3/4" W x 52-7/8" H x 18-1/2" D	100 lbs.

10 DOOR HIGH UNITS - 52-7/8" H

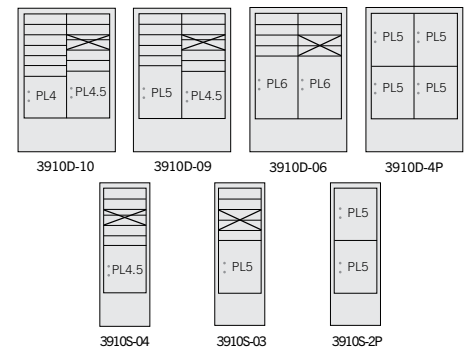

MODEL	DESCRIPTION	UNIT SIZE (includes enclosure)	WEIGHT
6 DOOR HIGH UNITS - 52-7/8" H (includes ADA compliant enclosure)			
3906D-10 ^{1,2}	10 MB1 Doors - no Parcel Lockers	31-3/4" W x 52-7/8" H x 18-1/2" D	155 lbs.
3906D-09 ^{1,2}	9 MB1 Doors - no Parcel Lockers	31-3/4" W x 52-7/8" H x 18-1/2" D	155 lbs.
3906D-05 ^{1,2}	5 MB1 Doors and 1 Parcel Locker (PL5)	31-3/4" W x 52-7/8" H x 18-1/2" D	150 lbs.
3906D-2P ^{1,2}	2 Parcel Lockers (PL6's)	31-3/4" W x 52-7/8" H x 18-1/2" D	145 lbs.
3906S-04 ^{1,2}	4 MB1 Doors - no Parcel Lockers	17-3/4" W x 52-7/8" H x 18-1/2" D	90 lbs.
3906S-03 ^{1,2}	3 MB1 Doors - no Parcel Lockers	17-3/4" W x 52-7/8" H x 18-1/2" D	90 lbs.
3906S-1P ^{1,2}	1 Parcel Locker (PL6)	17-3/4" W x 52-7/8" H x 18-1/2" D	85 lbs.

6 DOOR HIGH UNITS - 52-7/8" H

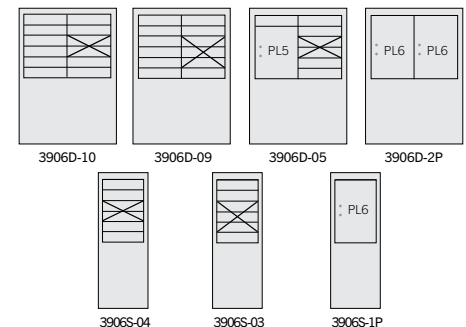

Current Pricing and Volume Discounts Available at Mailboxes.com!

¹ Specify

aluminum

bronze

sandstone

black

² Specify - U.S.P.S. access or private access (order #3775 master commercial lock for private access on FL units and PL's)

OUTGOING MAIL COMPARTMENT

Note: Free-Standing 4C horizontal mailboxes include a compartment for outgoing mail collection that is labeled "Outgoing Mail".

For custom 4C mailbox units, specifications & options - see pages 28-31

Custom 4C Horizontal Mailboxes

for specifications & options - see pages 30 - 31

CUSTOM 4C HORIZONTAL MAILBOXES

FRONT OR REAR LOADING 

Made of heavy duty aluminum and stainless steel hardware, Salsbury custom 4C horizontal mailboxes and parcel lockers are available as recessed mounted, surface mounted and free standing units in configurations that are one door wide (single column) and two (2) doors wide (double column). Units can be configured with a combination of four (4) mailbox door sizes and five (5) parcel locker door sizes to meet your custom requirements. To customize your unit, access our 4C mailbox configurator online at www.mailboxes.com/Mailbox-Configurator or submit a required layout for a price quotation. Custom 4C horizontal mailboxes feature a durable powder coated finish and are available in a variety of standard colors. Custom colors are also available as an option upon request. Custom 4C horizontal mailboxes are designed for indoor or outdoor use and are ideal for apartments, residential communities, commercial buildings and many other applications.

If Front Loading:

Units include one or two (2) master door(s) that swing(s) on continuous integral hinges. The outgoing mail compartment includes the access door and cannot be used for mail distribution. The rear of the unit incorporates a solid rear cover.

If Rear Loading:

The front of the outgoing mail compartment is comprised of fixed panels (no access door). The rear of the unit incorporates one or two (2) access door(s) with heavy duty latches and continuous hinges. Units are available without rear access doors upon request. Note: Rear loading access is only available for recessed mounted units.

4C

Note: Salsbury custom 4C horizontal mailboxes and parcel lockers are U.S.P.S. approved and meet the specifications of USPS-STD-4C. 4C mailboxes are required for new construction and major renovations.

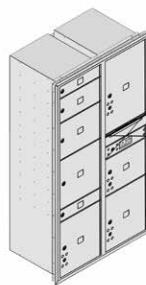

RECESSED MOUNTED
Custom 3700 Series Unit



SURFACE MOUNTED
Custom 3800 Series Unit

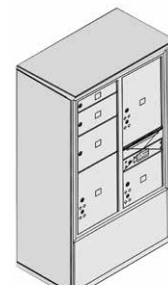

FREE-STANDING
Custom 3900 Series Unit



Front view of Custom Front Loading Recessed Mounted Double Column Unit displayed



Rear view of Custom Rear Loading Recessed Mounted Double Column Unit with Rear Access Doors displayed

Access our 4C Mailbox Configurator at:

www.mailboxes.com/Mailbox-Configurator

- Assist in determining the ideal combination of mailboxes and parcel lockers based on requirements
- Customize door configurations within recessed mounted, surface mounted and free-standing units
- Receive dimensional PDF, Word, Excel and AutoCAD drawing files for use in designing, quoting or ordering mailboxes



Customize individual units



Custom engraving available



Custom finishes available

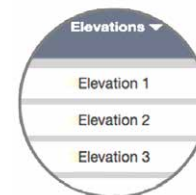

Design multiple elevations

ORDERING CUSTOM 4C HORIZONTAL UNITS

Following simple guidelines, custom units can be configured with a combination of four (4) mailbox door sizes and five (5) parcel locker door sizes.

SAMPLE DOUBLE COLUMN FRONT

- 1)** Determine the number of openings required using a combination of mailbox doors and parcel lockers listed below. Custom units can accommodate mailbox doors from 1 high (3-1/4") to 4 high (13-3/4") and parcel locker doors from 3 high (10-1/4") to 6 high (20-3/4").

MAILBOX DOOR SIZES:

- MB1 - 12-3/4" W x 3-1/4" H
- MB2 - 12-3/4" W x 6-3/4" H
- MB3 - 12-3/4" W x 10-1/4" H
- MB4 - 12-3/4" W x 13-3/4" H

PARCEL LOCKER DOOR SIZES:

- PL3 - 12-3/4" W x 10-1/4" H
- PL4 - 12-3/4" W x 13-3/4" H
- PL4.5 - 12-3/4" W x 15-1/2" H
- PL5 - 12-3/4" W x 17-1/4" H
- PL6 - 12-3/4" W x 20-3/4" H

- 2)** Configure your requirements into a one wide (single column) or two (2) wide (double column) unit and into equivalent standard mailbox door heights. The outgoing mail compartment / carrier access door must be situated between 36" and 48" above the finished floor (AFF). To customize the maximum height units, please access our 4C configurator at www.mailboxes.com/Mailbox-Configurator or contact our design engineers for layout, options and pricing.

- 3)** Specify the installation type:

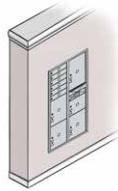

Recessed mounted
3700 Series
4C Horizontal
Mailboxes

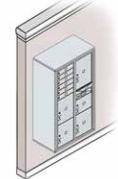

Surface mounted
3800 Series
4C Horizontal
Mailboxes

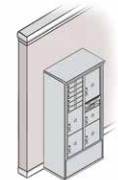

Free-standing
3900 Series
4C Horizontal
Mailboxes

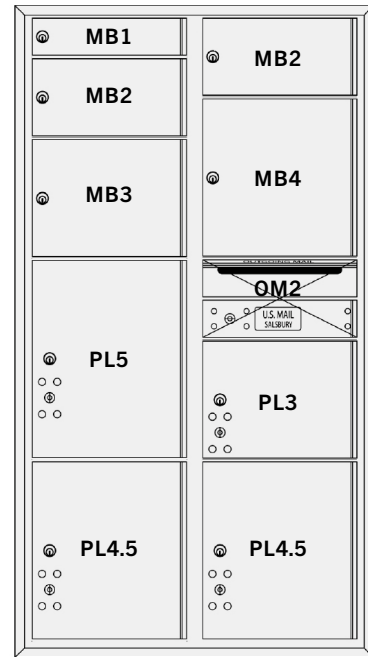

Note: U.S.P.S. standard 4C requires a minimum of one parcel locker for every five (5) tenant compartments. Parcel lockers are not required for installation sites with less than five (5) tenant compartments.

CUSTOM 4C HORIZONTAL MAILBOX PRICING FOR RECESSED MOUNTED MAILBOX UNITS

Note: Access our 4C Configurator for surface mounted and free-standing mailbox unit pricing

MODEL	DESCRIPTION	DOOR SIZE
MAILBOXES		
3700MB1 ^{1,2,3}	MB1 Door and 15" D Compartment	12-3/4" W x 3-1/4" H
3700MB2 ^{1,2,3}	MB2 Door and 15" D Compartment	12-3/4" W x 6-3/4" H
3700MB3 ^{1,2,3}	MB3 Door and 15" D Compartment	12-3/4" W x 10-1/4" H
3700MB4 ^{1,2,3}	MB4 Door and 15" D Compartment	12-3/4" W x 13-3/4" H
PARCEL LOCKERS		
3700PL3 ^{1,2,3}	PL3 Parcel Locker and 15" D Compartment	12-3/4" W x 10-1/4" H
3700PL4 ^{1,2,3}	PL4 Parcel Locker and 15" D Compartment	12-3/4" W x 13-3/4" H
3700PL4.5 ^{1,2,3}	PL4.5 Parcel Locker and 15" D Compartment	12-3/4" W x 15-1/2" H
3700PL5 ^{1,2,3}	PL5 Parcel Locker and 15" D Compartment	12-3/4" W x 17-1/4" H
3700PL6 ^{1,2,3}	PL6 Parcel Locker and 15" D Compartment	12-3/4" W x 20-3/4" H
OUTGOING MAIL COMPARTMENTS / CARRIER ACCESS DOORS		
3700OM2 ^{1,2,3}	OM2 Outgoing Mail Compartment / Carrier Access Doors*	12-3/4" W x 6-3/4" H
3700OM3 ^{1,2,3}	OM3 Outgoing Mail Compartment / Carrier Access Doors*	12-3/4" W x 10-1/2" H
3700CA ^{1,2,3}	Carrier Access Door*	12-3/4" W x 3-1/4" H
SPARE PARTS / OPTIONS		
3751 ¹	Door - MB1 replacement door and lock with (3) keys	12-3/4" W x 3-1/4" H
3752 ¹	Door - MB2 replacement door and lock with (3) keys	12-3/4" W x 6-3/4" H
3753 ¹	Door - MB3 replacement door and lock with (3) keys	12-3/4" W x 10-1/4" H
3754 ¹	Door - MB4 replacement door and lock with (3) keys	12-3/4" W x 13-3/4" H
3766	Custom finish (minimum order of (100) doors) - specify color - see color options at: www.mailboxes.com/4c-custom-horizontal-mailboxes	
3767	Custom engraved placard - for 4C horizontal mailbox doors and parcel lockers	
3768	Custom engraved door - regular - for 4C horizontal mailbox doors and parcel lockers	
3774	Custom engraved door - black filled - for 4C horizontal mailbox doors and parcel lockers	
3775	Master commercial lock - factory installed for private access on FL units and PL's - with (2) keys	
3776	Tenant parcel locker lock - with (3) keys	

* The Outgoing Mail Compartment / Carrier Access Door must be situated between 36" and 48" above the finished floor (AFF).

- ¹ Specify - aluminum, bronze, sandstone or black finishes are available for recessed mounted, surface mounted and free-standing mailbox units.
² Specify - front loading (FL) or rear loading (RL)
³ Specify - U.S.P.S. access or private access (order #3775 master commercial lock for private access on FL units and PL's)

Note: The price of custom 4C horizontal mailboxes is the total of each mailbox, parcel locker, master commercial lock and outgoing mail compartment within a unit plus enclosures (for 3800 and 3900 units) if necessary. Allow approximately 3-4 weeks production time for custom 4C horizontal mailboxes. For faster service, see pages 16-27 for standard configurations.

4C Horizontal Mailbox Specifications & Options

see 4C horizontal mailbox units on pages 16 - 29

- Manufactured by Salsbury Industries to USPS-STD-4C Specifications
- Required for New Construction and Major Renovations
- For Indoor or Outdoor Use
- Fully Integrated or Stand-Alone Parcel Lockers
- ADA Compliant Units Available 



- see pages 19, 23 and 27 or visit: www.mailboxes.com/ADA-4C-Mailboxes

Current Pricing and Volume Discounts Available at Mailboxes.com!



Note: Salsbury 4C horizontal mailboxes and parcel lockers are U.S.P. S. approved and meet the specifications of USPS-STD-4C. These units are required for new construction and major renovations.

4C MAILBOX CONFIGURATOR

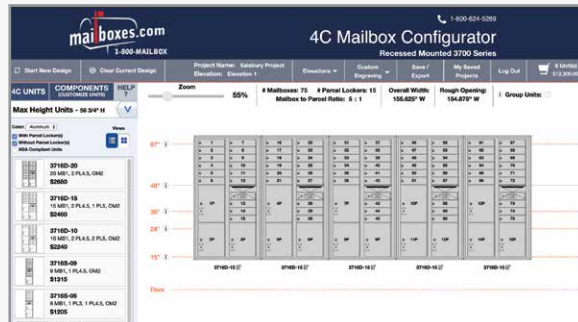

Access our 4C Configurator at:

www.mailboxes.com/Mailbox-Configurator

Our 4C mailbox configurator will assist in determining the ideal combination of mailboxes and parcel lockers based on your specific requirements. This robust tool also allows you to customize 4C mailbox units and add numbering sequences to drawings. In addition to clear and easy to read elevation line drawings with dimensions, our online mailbox configurator will also provide you with PDF, Word, Excel and AutoCAD drawing files to download for your project. Purchasing products and requesting a quote online is simple and convenient.

DESIGN ASSISTANCE

Our design engineers are available to architects, specification writers and individuals involved in the design of mail distribution facilities, apartment complexes and commercial buildings. Visit the informative Architect Resources section of our website at: www.mailboxes.com/Architectural-Resources to download specifications, technical drawings, AutoCAD and BIM/Revit models. You can also submit required layout and options for a price quotation.

Custom recessed mounted 4C horizontal mailboxes in aluminum finish with optional custom engraved doors -black filled (#3774) displayed

Front loading units include one or two (2) master door(s) that swing(s) on continuous integral hinges. The outgoing mail compartment includes the access door and cannot be used for mail distribution. The rear of the unit incorporates a solid rear cover. Note: U.S.P.S. standard 4C requires a minimum of one parcel locker for every five (5) tenant compartments. Parcel lockers are not required for installation sites with less than five (5) tenant compartments.

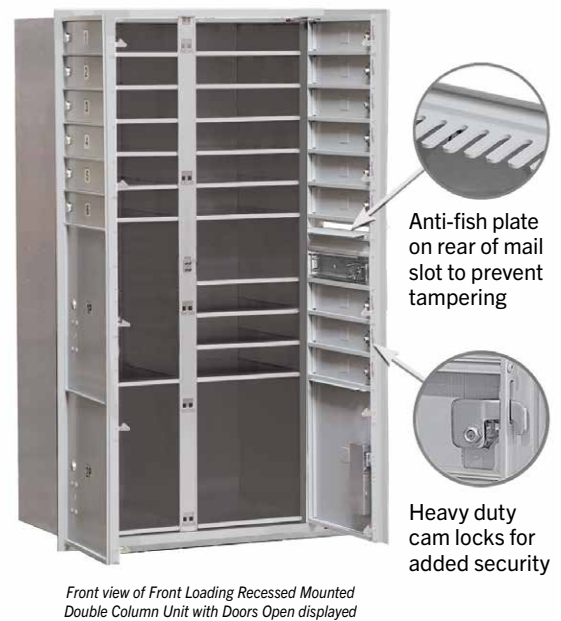
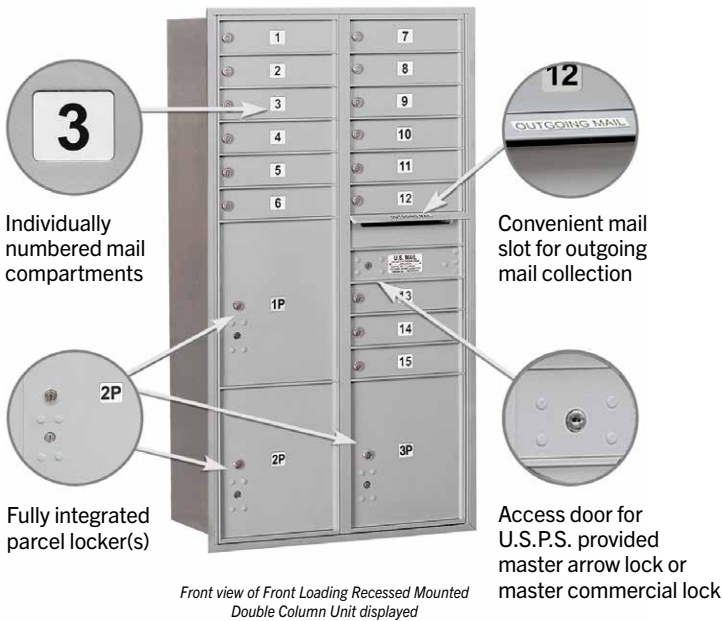

4C HORIZONTAL MAILBOX SPECIFICATIONS & OPTIONS

FOR RECESSED MOUNTED, SURFACE MOUNTED AND FREE-STANDING MAILBOX UNITS

MAILBOX DOOR SIZES
Each aluminum door includes a heavy duty five (5) pin cylinder cam lock with a dust/rain shield and three (3) keys.

PARCEL LOCKER DOOR SIZES
Parcel lockers offer tenants a convenient way to receive packages on site and are fit with a two (2) key security system.

12-3/4" 3-1/4"
MB1 (1 High)
#3751¹ Replacement MB1 door and lock

12-3/4" 10-1/4"
PL3 (3 High)
#3753P¹ Replacement PL3 door and lock

12-3/4" 6-3/4"
MB2 (2 High)
#3752¹ Replacement MB2 door and lock

12-3/4" 20-3/4"
PL6 (6 High)
#3756P¹ Replacement PL6 door and lock

12-3/4" 10-1/4"
MB3 (3 High)
#3753¹ Replacement MB3 door and lock

12-3/4" 13-3/4"
PL4 (4 High)
#3754P¹ Replacement PL4 door and lock

12-3/4" 13-3/4"
MB4 (4 High)
#3754¹ Replacement MB4 door and lock

12-3/4" 15-1/2"
PL4.5 (4.5 High)
#3754.5P¹ Replacement PL4.5 door and lock

12-3/4" 17-1/4"
PL5 (5 High)
#3755P¹ Replacement PL5 door and lock

12-3/4" 20-3/4"
PL6 (6 High)
#3756P¹ Replacement PL6 door and lock

¹ Specify

- aluminum
- bronze
- sandstone
- black

FINISHES

The durable and corrosion resistant 4C units feature a durable powder coated finish available in aluminum, bronze, sandstone or black. Custom finishes (#3766) are available as an option upon request – minimum order of (100) doors.

DOOR IDENTIFICATION

Each standard 4C horizontal mailbox door has a 1" high number. The outgoing mail compartment is labeled "Outgoing Mail" and the parcel locker(s) are labeled with a "1P", "2P", etc. Custom identification systems are available as an option upon request.

CUSTOM ENGRAVED PLACARDS

1-3/4" W x 1-1/2" H custom engraved self-adhesive placards are available as an option upon request. (#3767)

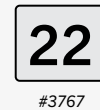

OUTGOING MAIL COMPARTMENTS

One compartment in each unit is labeled "Outgoing Mail" and includes a weather protection flap and a 11-3/4" W x 3/4" H mail slot.

CUSTOM ENGRAVED DOORS

- Custom engraved door – regular (#3768)
- Custom engraved door – black filled (#3774)

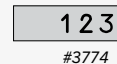

LOCKS

Each 4C mailbox door includes a heavy duty five (5) pin cylinder cam lock with a dust/rain shield and three (3) keys (2,000 different key changes). (#3790-5 - set of (5) #3790 locks)

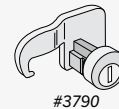

- Additional keys per lock when ordering (#3798)
- Key blanks - box of (50) (#3799)
- Custom lock installation - cylinders provided by owner (for installations not serviced by the U.S.P.S.) (100 door minimum) (#3793)

For installations NOT serviced by the U.S.P.S.

- Mail slots (#3769)
Standard slot size: 10-3/4" W x 3/4" H
Custom slot sizes are available upon request.
- Plexiglass window 1-1/8" W x 7/8" H (#3771)
- Outgoing mail slot plug kit (#3770)

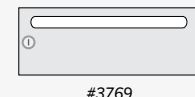

MASTER COMMERCIAL LOCK

Factory installed if for private access - for front loading mailboxes and parcel lockers - with (2) keys (#3775)

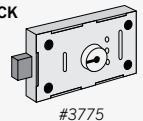

TENANT PARCEL LOCKER LOCK

For parcel locker door - with (3) keys (#3776)



COMBINATION LOCK

Three (3) digit single dial combination lock with spring latch and automatic throw-off (for installations not serviced by the U.S.P.S.). Combination numbers can be changed by owner. (#3786)

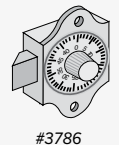

Standard 4B+ Horizontal Mailboxes

STANDARD 4B+ HORIZONTAL MAILBOXES

FRONT LOADING 

Made entirely of aluminum, Salsbury 3600 series U.S.P.S. approved standard 4B+ horizontal mailboxes are available in units with standard A doors and larger B doors. Units with standard "A" doors are available in 3, 4 or 5 doors wide and 5, 6 or 7 doors high. Units with larger "B" doors are available in 2 doors wide and 5, 6 or 7 doors high. Each aluminum door includes a five (5) pin cylinder cam lock with two (2) keys and a 2" W x 5/8" H clear plastic card holder (card included) to identify the tenant's name and/or box number. The mailbox compartments are made of sheet aluminum. Custom engraved placards (#3667) are available as an option upon request. Standard 4B+ horizontal mailboxes feature a durable powder coated finish available in three (3) contemporary colors and are ideal for apartments, condominiums, commercial buildings, colleges and schools and many other applications.

**Current Pricing and Volume Discounts
Available at Mailboxes.com!**



#3614's in aluminum finish displayed

4B+

Note: Salsbury 3600 series standard 4B+ horizontal mailboxes are U.S.P.S. approved to the required security upgrades of USPS-STD-4B+. These mailboxes are approved for replacement and/or retrofit installations. For new construction and major renovations, see 4C horizontal mailboxes on pages 16-31.

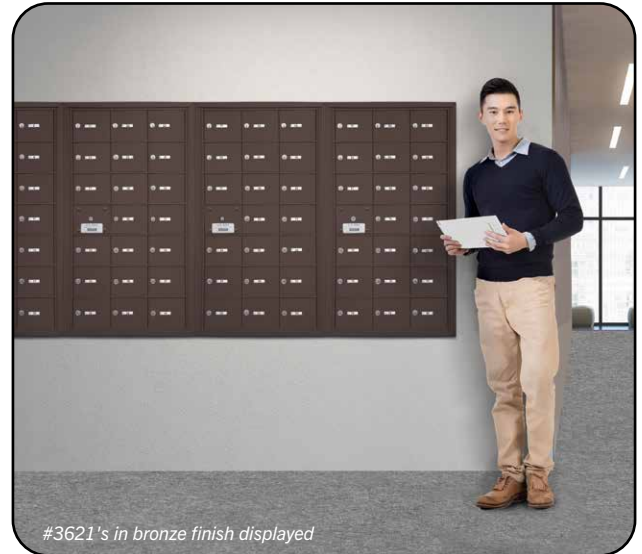

#3621's in bronze finish displayed

SAMPLE INSTALLATION

Model displayed:
(2) 3635 Front
Loading Units

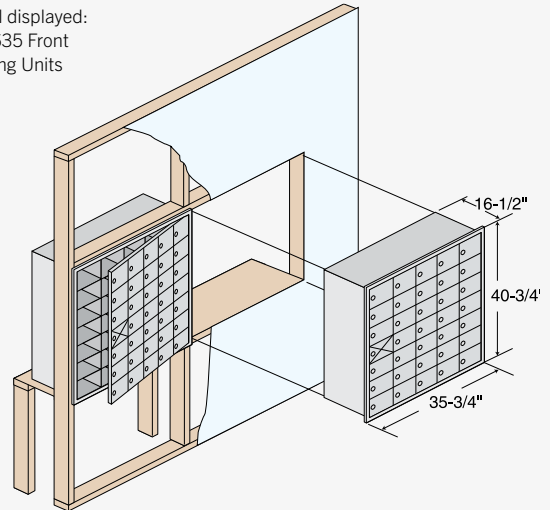

Note: For U.S.P.S. serviced installations, the tenant locks in the top row of mailboxes must be no more than 67" above the finished floor and the bottom of the lowest row must be no less than 28" above the finished floor.

CUSTOM 4B+ HORIZONTAL MAILBOXES

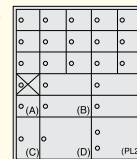

- Larger door sizes
- Parcel lockers
- Custom configurations
- Rear loading units
- Collection units



Front loading units include a door panel that swings on a continuous hinge. One mailbox opening is required for a master postal or commercial lock and cannot be used for mail distribution. Units include factory installed 3/4" W x 1/4" D trim and a solid rear cover.



3628
28 Front Loading
A doors (27 usable)



3635
35 Front Loading
A doors (34 usable)



3614
14 Front Loading
B doors (13 usable)

STANDARD 4B+ HORIZONTAL MAILBOXES - FRONT LOADING - U.S.P.S. APPROVED

MODEL	DESCRIPTION	UNIT SIZE (includes trim)	WEIGHT
7 DOOR HIGH UNITS - 40-3/4" H			
3621 ^{1,2}	21 A Doors (20 usable on FL)	22-3/4" W x 40-3/4" H x 16-1/2" D	70 lbs.
3628 ^{1,2}	28 A Doors (27 usable on FL)	29-1/4" W x 40-3/4" H x 16-1/2" D	85 lbs.
3635 ^{1,2}	35 A Doors (34 usable on FL)	35-3/4" W x 40-3/4" H x 16-1/2" D	100 lbs.
3614 ^{1,2}	14 B Doors (13 usable on FL)	29-1/4" W x 40-3/4" H x 16-1/2" D	85 lbs.
6 DOOR HIGH UNITS - 35-1/4" H			
3618 ^{1,2}	18 A Doors (17 usable on FL)	22-3/4" W x 35-1/4" H x 16-1/2" D	60 lbs.
3624 ^{1,2}	24 A Doors (23 usable on FL)	29-1/4" W x 35-1/4" H x 16-1/2" D	75 lbs.
3630 ^{1,2}	30 A Doors (29 usable on FL)	35-3/4" W x 35-1/4" H x 16-1/2" D	90 lbs.
3612 ^{1,2}	12 B Doors (11 usable on FL)	29-1/4" W x 35-1/4" H x 16-1/2" D	75 lbs.
5 DOOR HIGH UNITS - 29-3/4" H			
3615 ^{1,2}	15 A Doors (14 usable on FL)	22-3/4" W x 29-3/4" H x 16-1/2" D	55 lbs.
3620 ^{1,2}	20 A Doors (19 usable on FL)	29-1/4" W x 29-3/4" H x 16-1/2" D	65 lbs.
3625 ^{1,2}	25 A Doors (24 usable on FL)	35-3/4" W x 29-3/4" H x 16-1/2" D	75 lbs.
3610 ^{1,2}	10 B Doors (9 usable on FL)	29-1/4" W x 29-3/4" H x 16-1/2" D	65 lbs.

- 3668 Custom engraved door - regular - for 3600 series mailbox doors and parcel lockers
- 3674 Custom engraved door - black filled - for 3600 series mailbox doors and parcel lockers
- 3675 Master commercial lock - factory installed if for private access - for FL mailboxes - with (2) keys
- 3686 Combination lock - 3 digit spring latch - additional per door - for installations not serviced by the U.S.P.S.
- 3690-5 Set of (5) #3690 locks - standard replacement for 3600 series doors - with (2) keys
- 3699 Key blanks - for standard 3600 series locks - box of (50)

ACCESS DOOR
On 3600 series front loading horizontal mailboxes, one opening per unit is required for a master postal or commercial lock and cannot be used for mail distribution.

STANDARD FRONT LOADING CONFIGURATIONS

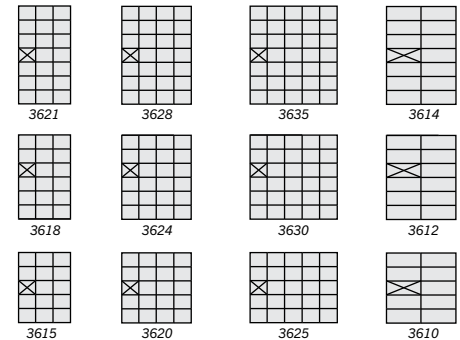

3600 SERIES DOOR SIZES

6-1/2" x 5-1/4" **A**

#3651¹
Replacement "A" door and lock

13" x 5-1/4" **B**

#3652¹
Replacement "B" door and lock

STANDARD 4B+ HORIZONTAL MAILBOX OPTIONS

Each mailbox door includes a five (5) pin cylinder cam lock with two (2) keys (1,000 different key changes).

- Lock - for 3600 series (#3690-5 - set of (5) #3690 locks)
- Additional keys per lock when ordering (#3698)
- Key blanks - box of (50) (#3699)



#3690 Lock for 3600 series



#3698 Additional keys for #3690

- Master commercial lock - with (2) keys - factory installed if for private access - for front loading mailboxes (#3675)
- Card holder - clear plastic - card and metal insert included (#3697)
- Self-adhesive numbers - sheets of (100) (#3695)
- 4B+ Master door security retrofit kit (#3696)

1 Specify

aluminum bronze sandstone

2 Specify - U.S.P.S. access or private access (order #3675 master commercial lock for private access on FL units and PL's)

DOOR AND COMPARTMENT IDENTIFICATION

Each mailbox door includes a 2" W x 5/8" H clear plastic card holder (#3697) to identify the tenant's name and/or box number. Self-adhesive numbers (1-3000 available) are supplied upon request with a standard order. Custom identification systems are available as an option upon request. Label holders (#1070) neatly organize and identify the front/rear of the mailbox compartments and are available as an option upon request.

- Custom engraved placards - 2" W x 5/8" H (#3667)
- Custom engraved door - regular (door will be solid - no card holder) (#3668)
- Custom engraved door - black filled (door will be solid - no card holder) (#3674)

123

1 2 3

1 2 3

Vertical Mailboxes

VERTICAL MAILBOXES

FRONT LOADING 

Made entirely of aluminum, Salsbury 3500 series U.S.P.S. approved vertical mailboxes are available in surface mounted and recessed mounted units. The mailboxes feature 5-1/2" W x 16-1/4" H extruded aluminum doors and a durable powder coated finish available in three (3) contemporary colors. Each mailbox door includes a five (5) pin cylinder cam lock with two (2) keys and a 2-1/2" W x 5/8" H indentation to accommodate a label (included) to identify the tenant's name and/or box number. Custom identification systems are available as an option upon request. Mailboxes are available in units with three (3) to seven (7) compartments. Each compartment is 6-3/4" deep. Vertical mailboxes are ideal for apartments, condominiums, commercial buildings and many other applications.

**Current Pricing and Volume Discounts
Available at Mailboxes.com!**



#3507 recessed units with optional custom engraved placards (#3567) displayed

4B+

Note: Salsbury 3500 series 4B+ vertical mailboxes have been U.S.P.S. approved to the required security upgrades of USPS-STD-4B+. These mailboxes are approved for replacement and/or retrofit installations. For new construction and major renovations, see 4C horizontal mailboxes on pages 16-31.

SAMPLE INSTALLATION

Model displayed:
(2) 3503's

Recessed mounted units fit into a rough opening and are secured with mounting hardware through the back or side panels. Recessed units feature a fully integrated flanged collar which fits over the rough opening.

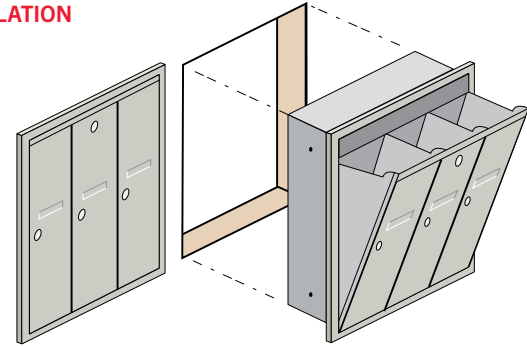

Note: For U.S.P.S. accessed vertical mailboxes, the master lock in the top tier of mailboxes must be no more than 58" above the finished floor. The master lock in the bottom tier of mailboxes must be no less than 30" above the finished floor. No more than two (2) tiers of mailboxes may be installed.

Note: Rough opening for recessed mounted vertical mailboxes is 1-1/2" less than the unit's width, 1-1/4" less than the unit's height and equal to the unit's depth.

Note: Rough opening for recessed letter boxes (#2245) is 13-3/4" W x 17-3/4" H x 6-3/4" D.

**3500
SERIES
DOOR SIZE**



**3551¹
Replacement
door and lock**

VERTICAL MAILBOX OPTIONS

OPTIONS

- Outgoing mail slot - in the far left door of the unit unless otherwise specified (#3569)
- 4B+ Master door security retrofit kit (#3596)

LOCKS

- Each mailbox door includes a five (5) pin cylinder cam lock with (2) keys (1,000 different key changes). (#3590-5 - set of (5) #3590 locks) (#3598)
- Additional keys per lock when ordering (#3598)
- Key blanks - box of (50) (#3599)

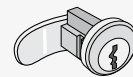

#3590
Lock
for 3500 series



#3598
Additional keys
for #3590

KEY KEEPERS

Made of 20 gauge steel, Salsbury key keepers are available as surface mounted or recessed mounted units and feature a durable powder coated finish. A key keeper allows the U.S.P.S. or other individuals to access a key and deliver the mail and is useful when restricted access to a building or mailroom is required.

1080^{1,2} - Key Keeper - surface mounted

- 6" W x 3-1/4" H x 2" D
- 2 lbs.



1080

1090^{1,2} - Key Keeper - recessed mounted

- 6" W x 3-1/4" H x 2" D
- rough opening:
5" W x 2-1/2" H x 1-3/4" D
- 2 lbs.



1090

- ¹ Specify
- aluminum
 - bronze
- ² Specify
- For U.S.P.S. access
 - For private access (order commercial lock #1095)



3503



3504



3505



3506



3507

VERTICAL MAILBOXES - FRONT LOADING - U.S.P.S. APPROVED

MODEL	DESCRIPTION	UNIT SIZE	WEIGHT
3503 ^{1,2,3}	3 Doors	18-3/4" W x 19" H x 7-1/2" D	25 lbs.
3504 ^{1,2,3}	4 Doors	24-1/4" W x 19" H x 7-1/2" D	30 lbs.
3505 ^{1,2,3}	5 Doors	29-3/4" W x 19" H x 7-1/2" D	35 lbs.
3506 ^{1,2,3}	6 Doors	35-1/4" W x 19" H x 7-1/2" D	40 lbs.
3507 ^{1,2,3}	7 Doors	40-3/4" W x 19" H x 7-1/2" D	45 lbs.
3575	Master commercial lock - factory installed if for private access - with (2) keys		
3590-5	Set of (5) #3590 locks - standard replacement for 3500 series doors - with (2) keys		
3599	Key blanks - for standard 3500 series locks - box of (50)		
2240 ^{1,4}	Letter Box - surface mounted	15" W x 19" H x 7-1/2" D	20 lbs.
2245 ^{1,4}	Letter Box - recessed mounted	15" W x 19" H x 6-3/4" D	20 lbs.
2246	Master commercial lock - factory installed if for private access - with (2) keys		

LETTER BOXES USPS or PRIVATE ACCESS

A letter box is an ideal way to collect outgoing mail or other correspondence. See pages 40-41 for additional products and specifications.

CUSTOM ENGRAVING (OPTION - #2266)

Custom engraving for letter boxes (specify regular or black filled) is available as an option upon request. See page 47 for specifications.

OUTGOING MAIL SLOT (OPTION - #3569)

A 4-3/8" W x 1/2" H outgoing mail slot is available as an option upon request. It will be located in the far left door of the unit unless otherwise specified. If a mail slot is requested, order unit with one additional compartment than the total number of tenants receiving mail.

CUSTOM ENGRAVED PLACARDS (OPTION - #3567)

2-1/2" W x 5/8" H custom engraved self-adhesive placards are available as an option upon request.

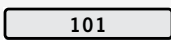

2240

- ¹ Specify aluminum bronze sandstone

- ² Specify - surface mounted or recessed mounted
- ³ Specify - U.S.P.S. access or private access (order master commercial lock #3575)
- ⁴ Specify - U.S.P.S. access or private access (order master commercial lock #2246)